

APPENDIX E
Alternative Figures

FIGURES

Figure E-1a. Pass-a-Loutre Wildlife Management Area Crevasse Access.....	E-1
Figure E-1b. Pass-a-Loutre Wildlife Management Area Crevasse Access.....	E-1
Figure E-1c. Pass-a-Loutre Wildlife Management Area Crevasse Access.....	E-2
Figure E-1d. Pass-a-Loutre Wildlife Management Area Crevasse Access.....	E-2
Figure E-1e. Pass-a-Loutre Wildlife Management Area Crevasse Access.....	E-3
Figure E-1f. Pass-a-Loutre Wildlife Management Area Crevasse Access.....	E-3
Figure E-1g. Pass-a-Loutre Wildlife Management Area Crevasse Access.....	E-4
Figure E-2a. Pass-a-Loutre Wildlife Management Area Campgrounds.....	E-4
Figure E-2b. Pass-a-Loutre Wildlife Management Area Campgrounds.....	E-5
Figure E-2c. Pass-a-Loutre Wildlife Management Area Campgrounds.....	E-5
Figure E-2d. Pass-a-Loutre Wildlife Management Area Campgrounds.....	E-6
Figure E-2e. Pass-a-Loutre Wildlife Management Area Campgrounds.....	E-6
Figure E-2f. Pass-a-Loutre Wildlife Management Area Campgrounds.....	E-7
Figure E-2g. Pass-a-Loutre Wildlife Management Area Campgrounds.....	E-7
Figure E-2h. Pass-a-Loutre Wildlife Management Area Campgrounds.....	E-8
Figure E-2i. Pass-a-Loutre Wildlife Management Area Campgrounds.....	E-8
Figure E-2j. Pass-a-Loutre Wildlife Management Area Campgrounds.....	E-9
Figure E-3. Chitimacha Boat Launch.....	E-10
Figure E-4a. Pointe-aux-Chenes Wildlife Management Area Recreation Use Enhancement, pirogue pull-over.....	E-11
Figure E-4b. Pointe-aux-Chenes Wildlife Management Area Recreation Use Enhancement, pirogue pull-over.....	E-12
Figure E-4c. Pointe-aux-Chenes Wildlife Management Area Recreation Use Enhancement, pirogue pull-over.....	E-13
Figure E-4d. Pointe-aux-Chenes Wildlife Management Area Recreation Use Enhancement, pirogue pull-over.....	E-14
Figure E-4e. Pointe-aux-Chenes Wildlife Management Area Recreation Use Enhancement, pirogue pull-over.....	E-15
Figure E-4f. Pointe-aux-Chenes Wildlife Management Area Recreation Use Enhancement, pirogue pull-over.....	E-16
Figure E-5a. Pointe-aux-Chenes Wildlife Management Area Recreation Use Enhancement, pirogue launch.....	E-17
Figure E-5b. Pointe-aux-Chenes Wildlife Management Area Recreation Use Enhancement, pirogue launch.....	E-18
Figure E-5c. Pointe-aux-Chenes Wildlife Management Area Recreation Use Enhancement, pirogue launch.....	E-19
Figure E-5d. Pointe-aux-Chenes Wildlife Management Area Recreation Use Enhancement, pirogue launch.....	E-20
Figure E-5e. Pointe-aux-Chenes Wildlife Management Area Recreation Use Enhancement, pirogue launch.....	E-21
Figure E-5f. Pointe-aux-Chenes Wildlife Management Area Recreation Use Enhancement, pirogue launch.....	E-22
Figure E-5g. Pointe-aux-Chenes Wildlife Management Area Recreation Use Enhancement, pirogue launch.....	E-23
Figure E-5h. Pointe-aux-Chenes Wildlife Management Area Recreation Use Enhancement, pirogue launch.....	E-24

Figure E-6a. Pointe-aux-Chenes Wildlife Management Area Recreation Use Enhancement, access improvements.	E-25
Figure E-6b. Pointe-aux-Chenes Wildlife Management Area Recreation Use Enhancement, access improvements.	E-26
Figure E-6c. Pointe-aux-Chenes Wildlife Management Area Recreation Use Enhancement, access improvements.	E-27
Figure E-6d. Pointe-aux-Chenes Wildlife Management Area Recreation Use Enhancement, access improvements.	E-28
Figure E-6e. Pointe-aux-Chenes Wildlife Management Area Recreation Use Enhancement, access improvements.	E-29
Figure E-6f. Pointe-aux-Chenes Wildlife Management Area Recreation Use Enhancement, access improvements.	E-30
Figure E-7a. Pointe-aux-Chenes Wildlife Management Area Recreation Use Enhancement, fishing piers at water control structures.	E-31
Figure E-7b. Pointe-aux-Chenes Wildlife Management Area Recreation Use Enhancement, fishing piers at water control structures.	E-32
Figure E-7c. Pointe-aux-Chenes Wildlife Management Area Recreation Use Enhancement, fishing piers at water control structures.	E-33
Figure E-7d. Pointe-aux-Chenes Wildlife Management Area Recreation Use Enhancement, fishing piers at water control structures.	E-34
Figure E-7e. Pointe-aux-Chenes Wildlife Management Area Recreation Use Enhancement, fishing piers at water control structures.	E-35
Figure E-7f. Pointe-aux-Chenes Wildlife Management Area Recreation Use Enhancement, fishing piers at water control structures.	E-36
Figure E-7g. Pointe-aux-Chenes Wildlife Management Area Recreation Use Enhancement, fishing piers at water control structures.	E-37
Figure E-7h. Pointe-aux-Chenes Wildlife Management Area Recreation Use Enhancement, fishing piers at water control structures.	E-38
Figure E-7i. Pointe-aux-Chenes Wildlife Management Area Recreation Use Enhancement, fishing piers at water control structures.	E-39
Figure E-8a. Atchafalaya Delta Wildlife Management Area Access.	E-40
Figure E-8b. Atchafalaya Delta Wildlife Management Area Access.	E-40
Figure E-8c. Atchafalaya Delta Wildlife Management Area Access.	E-41
Figure E-8d. Atchafalaya Delta Wildlife Management Area Access.	E-41
Figure E-9a. Atchafalaya Delta Wildlife Management Area Campgrounds.	E-42
Figure E-9b. Atchafalaya Delta Wildlife Management Area Campgrounds.	E-42
Figure E-9c. Atchafalaya Delta Wildlife Management Area Campgrounds.	E-43
Figure E-10a. The Wetlands Center.	E-43
Figure E-10b. The Wetlands Center.	E-44
Figure E-10c. The Wetlands Center.	E-44
Figure E-10d. The Wetlands Center.	E-45
Figure E-11. Jean Lafitte National Historic Park and Preserve, Barataria Preserve Unit.	E-46
Figure E-12a. Des Allemands Boat Launch in St. Charles Parish.	E-47
Figure E-12b. Des Allemands Boat Launch in St. Charles Parish.	E-47
Figure E-12c. Des Allemands Boat Launch in St. Charles Parish.	E-48
Figure E-12d. Des Allemands Boat Launch in St. Charles Parish.	E-48
Figure E-13a. Improvements to Grand Avoille Boat Launch in St. Mary Parish.	E-49
Figure E-13b. Improvements to Grand Avoille Boat Launch in St. Mary Parish.	E-49
Figure E-13c. Improvements to Grand Avoille Boat Launch in St. Mary Parish.	E-50

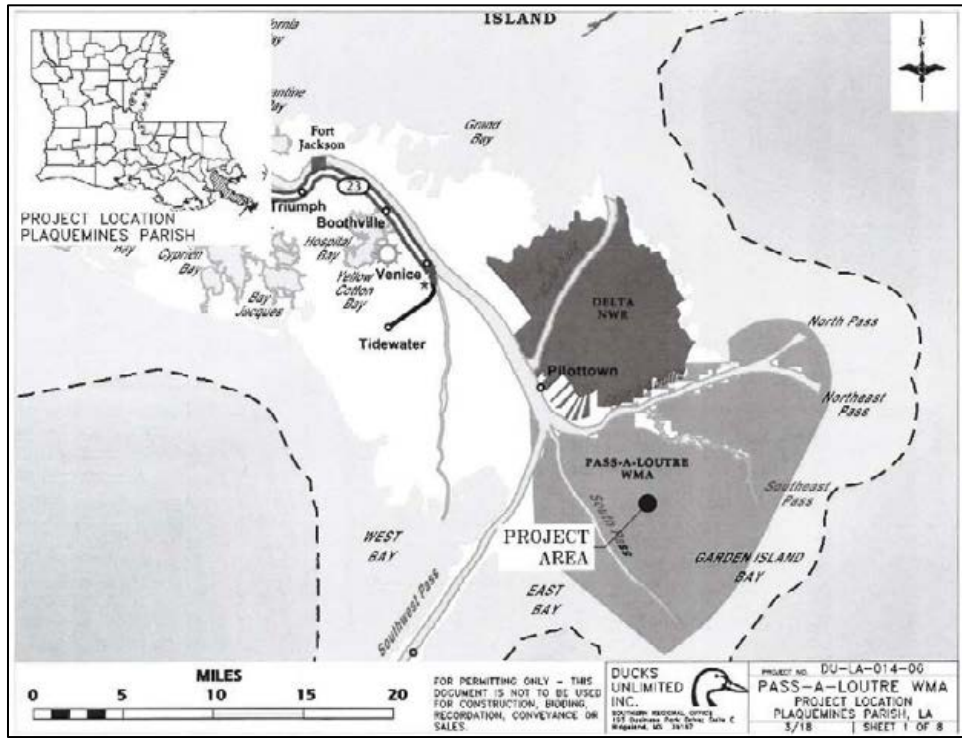

Figure E-1a. Pass-a-Loutre Wildlife Management Area Crevasse Access.



Figure E-1b. Pass-a-Loutre Wildlife Management Area Crevasse Access.

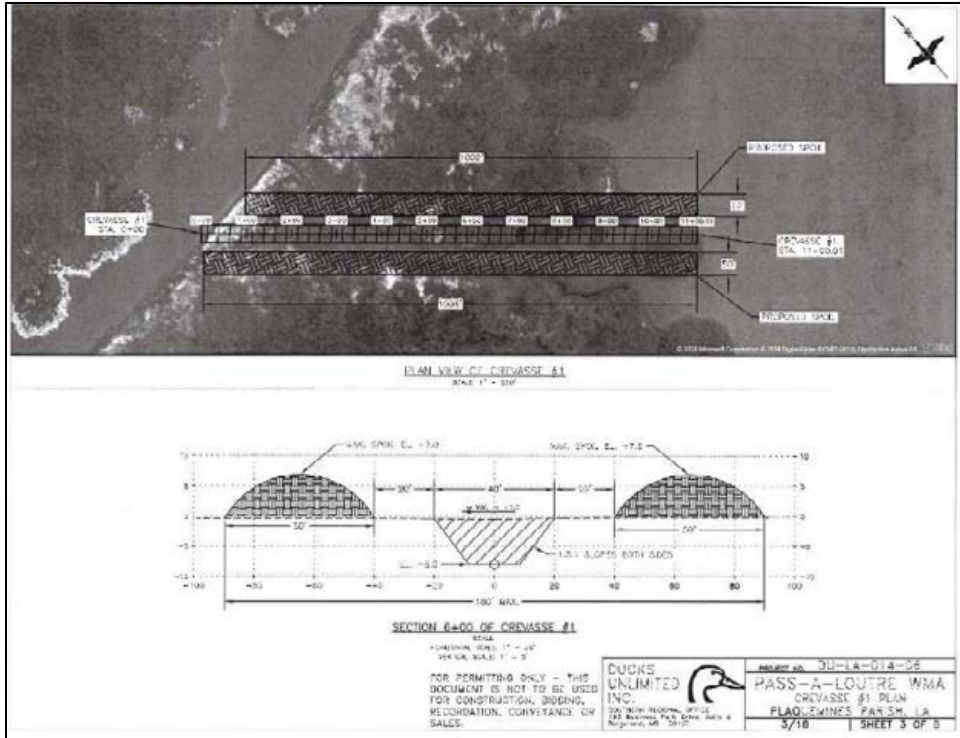

Figure E-1c. Pass-a-Loutre Wildlife Management Area Crevasse Access.

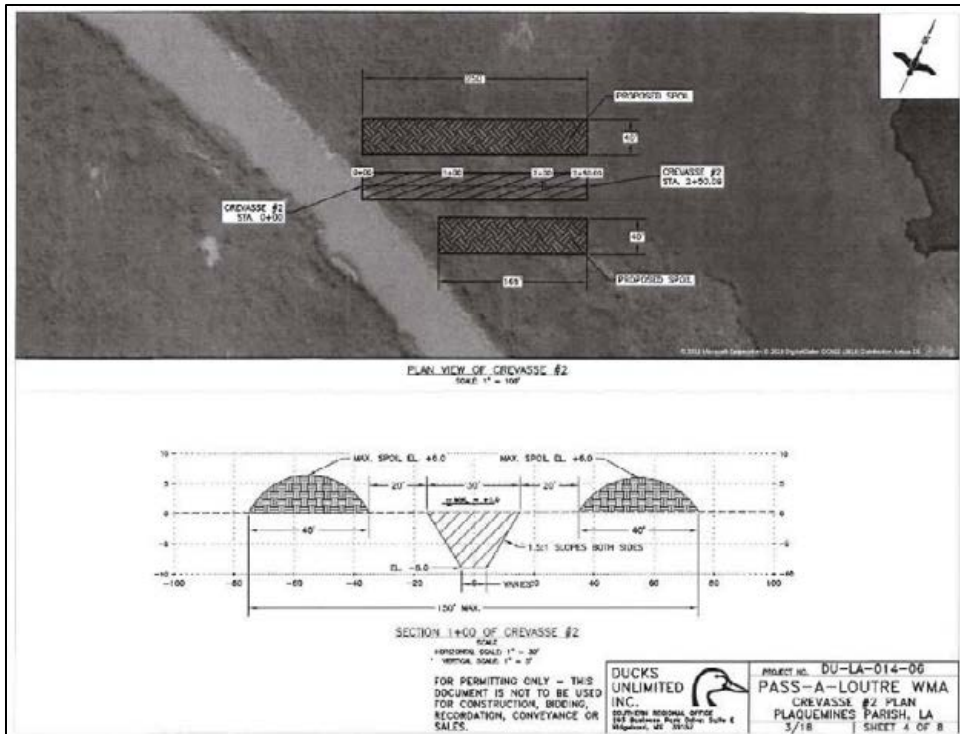

Figure E-1d. Pass-a-Loutre Wildlife Management Area Crevasse Access.

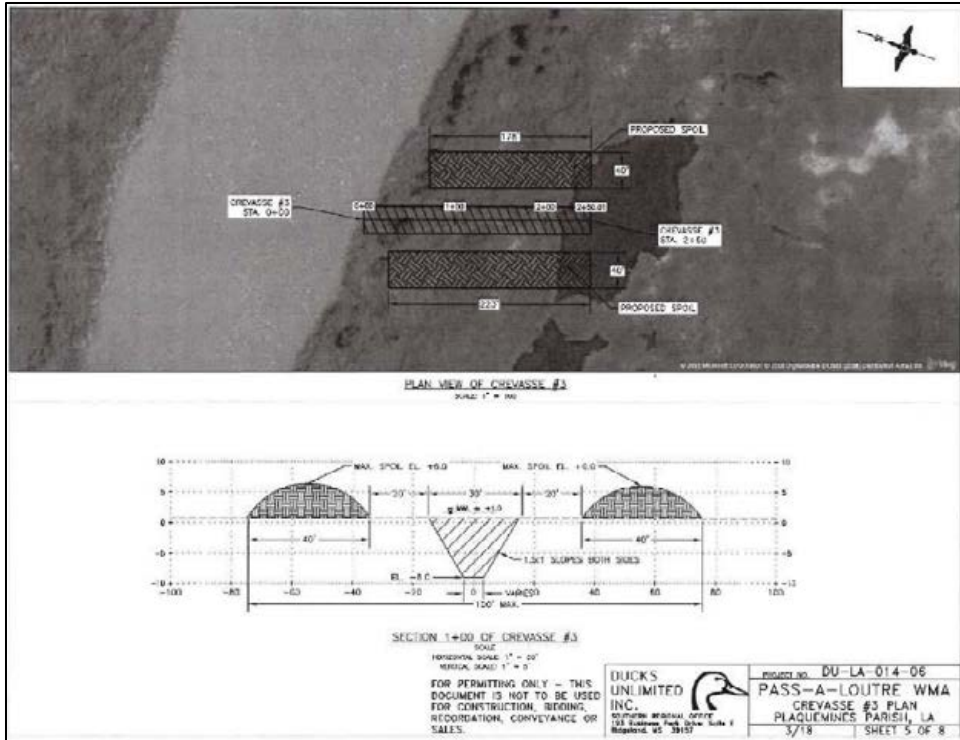

Figure E-1e. Pass-a-Loutre Wildlife Management Area Crevasse Access.

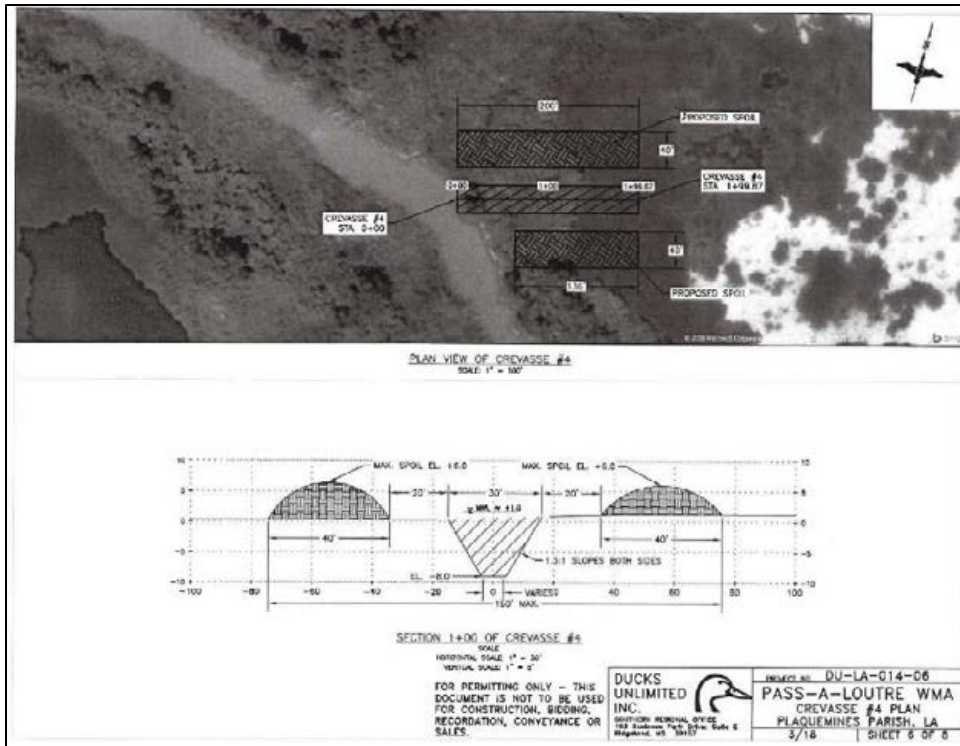

Figure E-1f. Pass-a-Loutre Wildlife Management Area Crevasse Access.

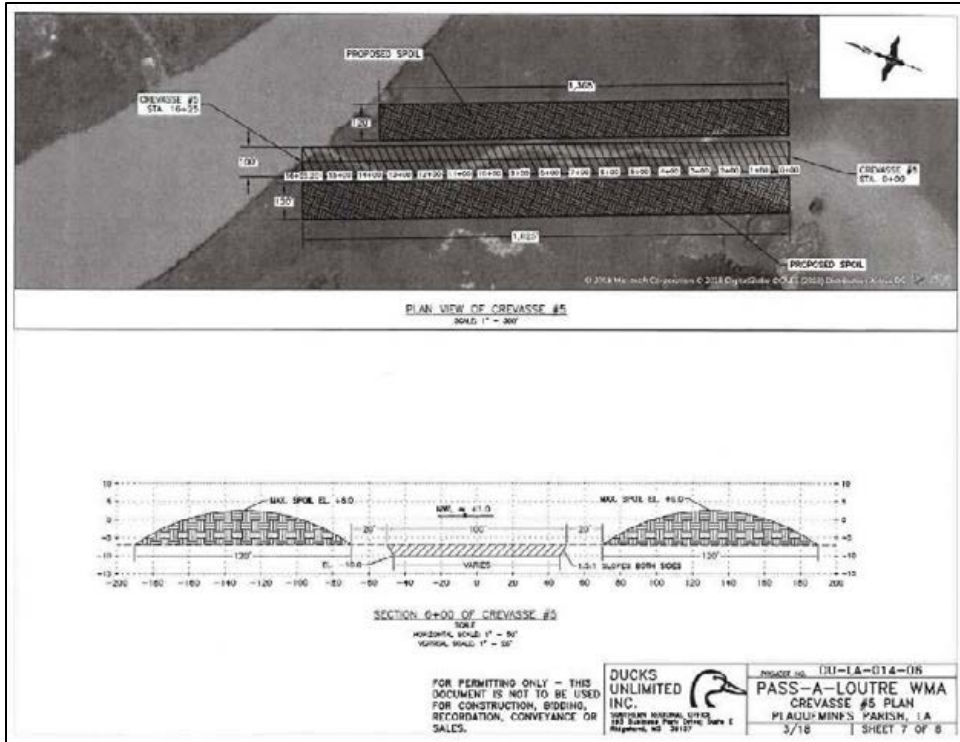

Figure E-1g. Pass-a-Loutre Wildlife Management Area Crevasse Access.

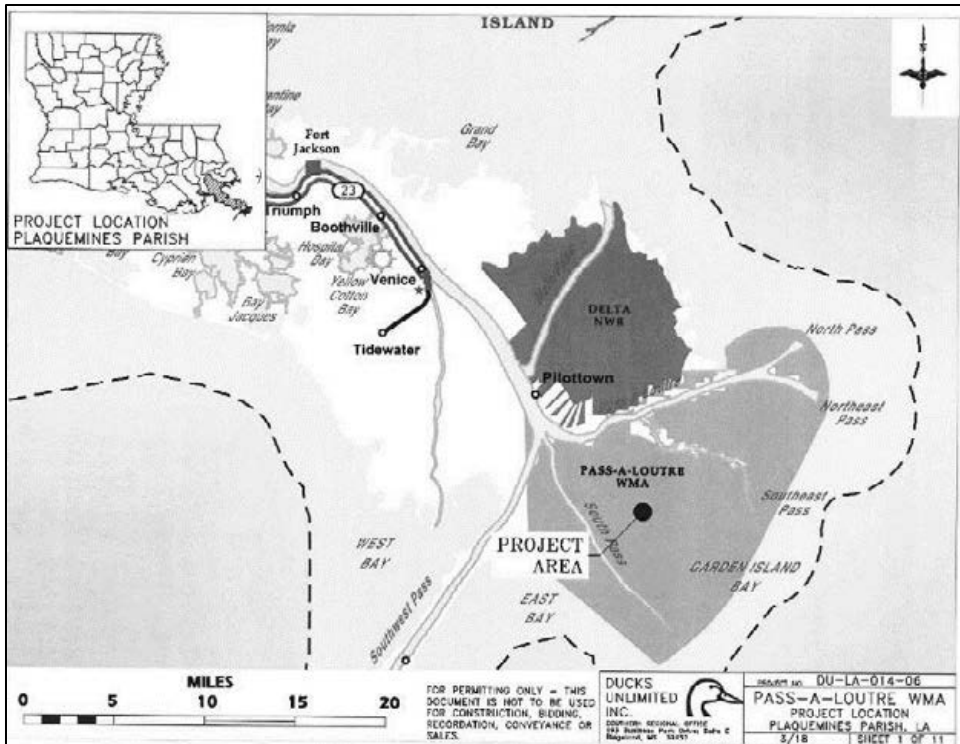

Figure E-2a. Pass-a-Loutre Wildlife Management Area Campgrounds.

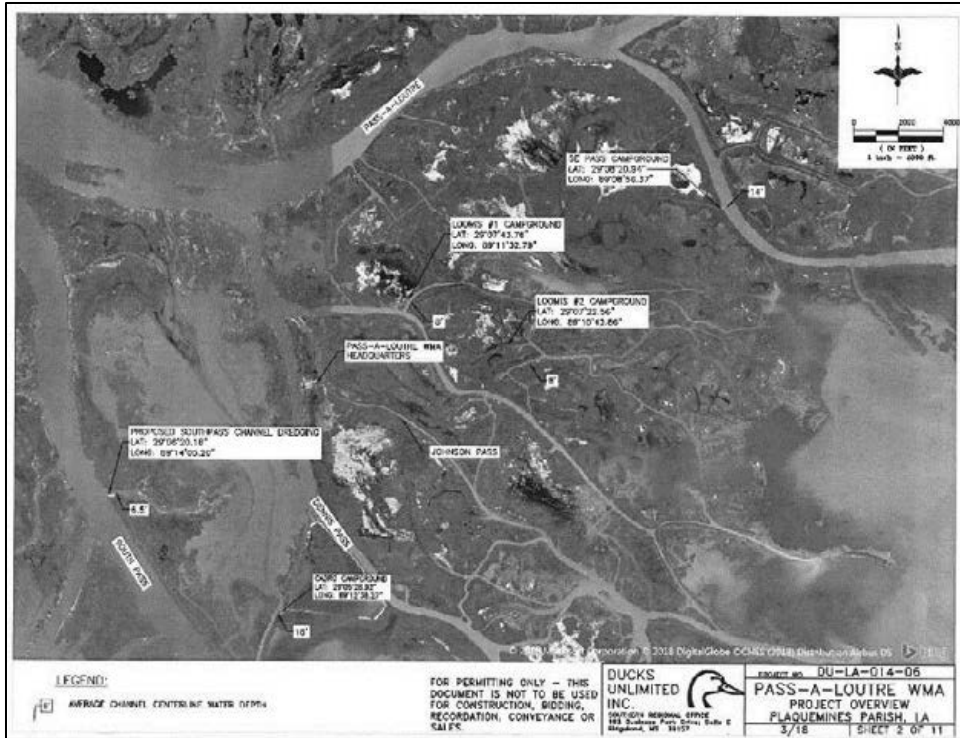

Figure E-2b. Pass-a-Loutre Wildlife Management Area Campgrounds.

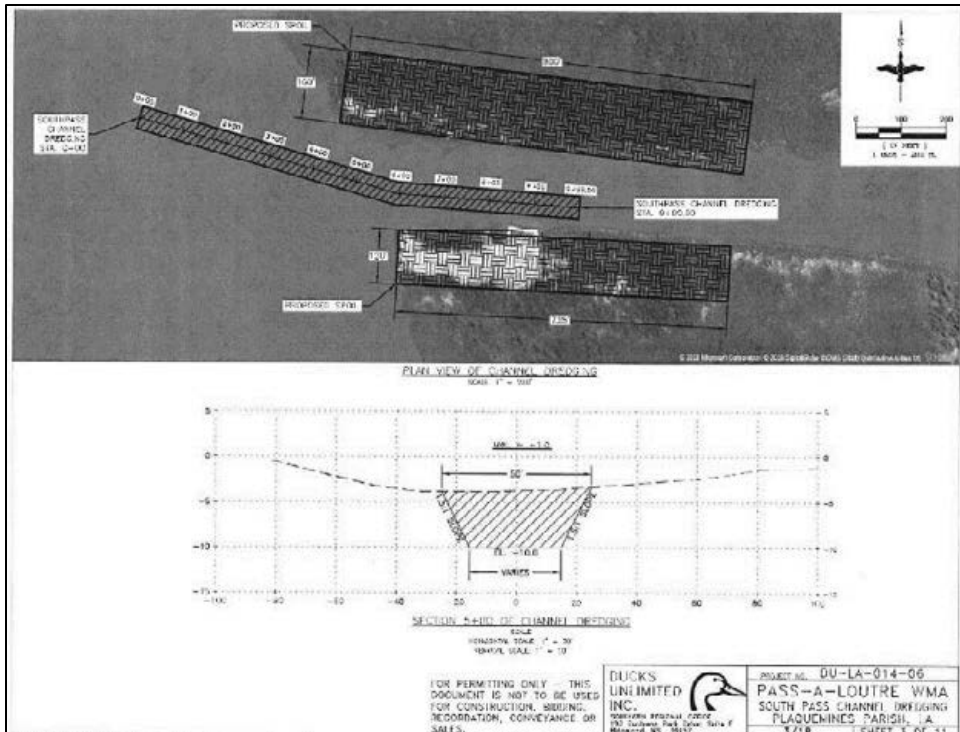

Figure E-2c. Pass-a-Loutre Wildlife Management Area Campgrounds.

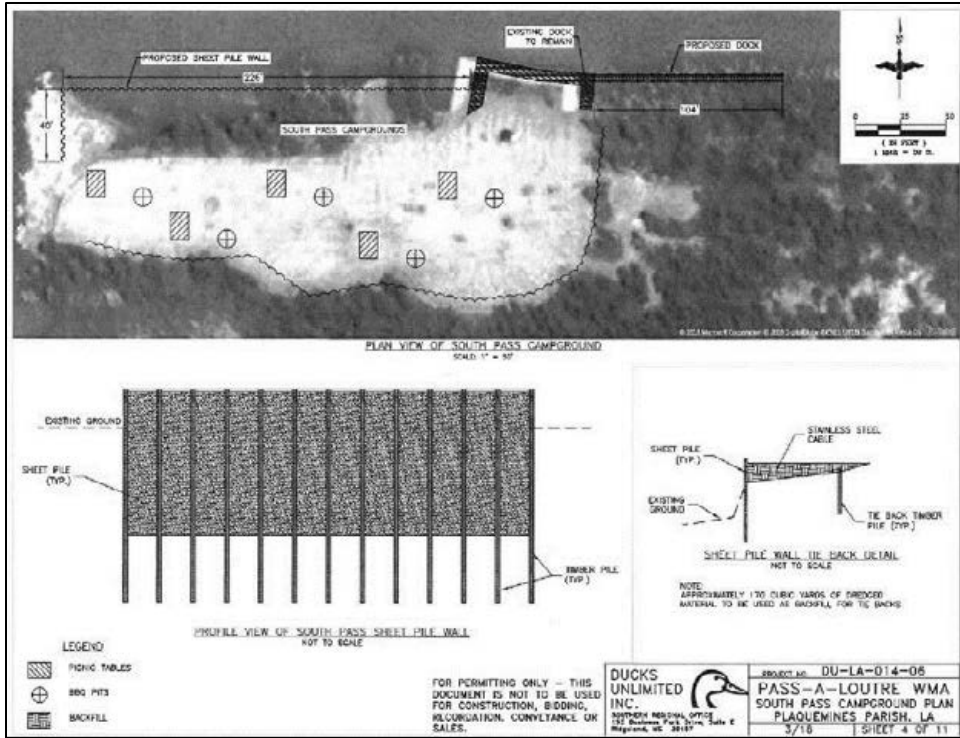

Figure E-2d. Pass-a-Loutré Wildlife Management Area Campgrounds.



Figure E-2e. Pass-a-Loutré Wildlife Management Area Campgrounds.



Figure E-2f. Pass-a-Loutre Wildlife Management Area Campgrounds.



Figure E-2g. Pass-a-Loutre Wildlife Management Area Campgrounds.

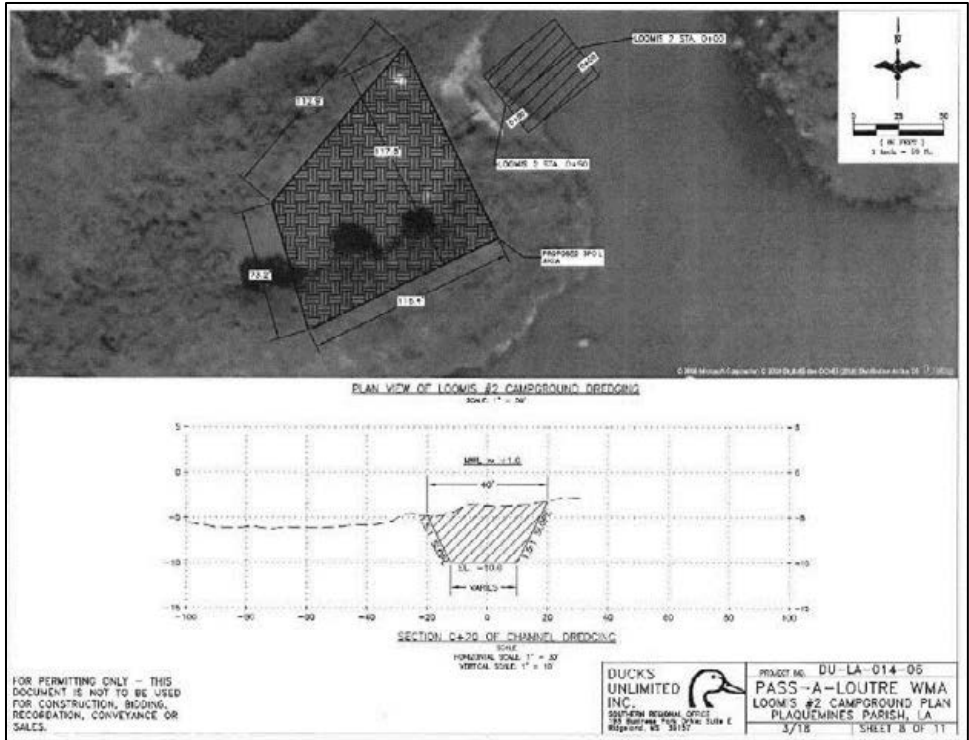

Figure E-2h. Pass-a-Loutre Wildlife Management Area Campgrounds.

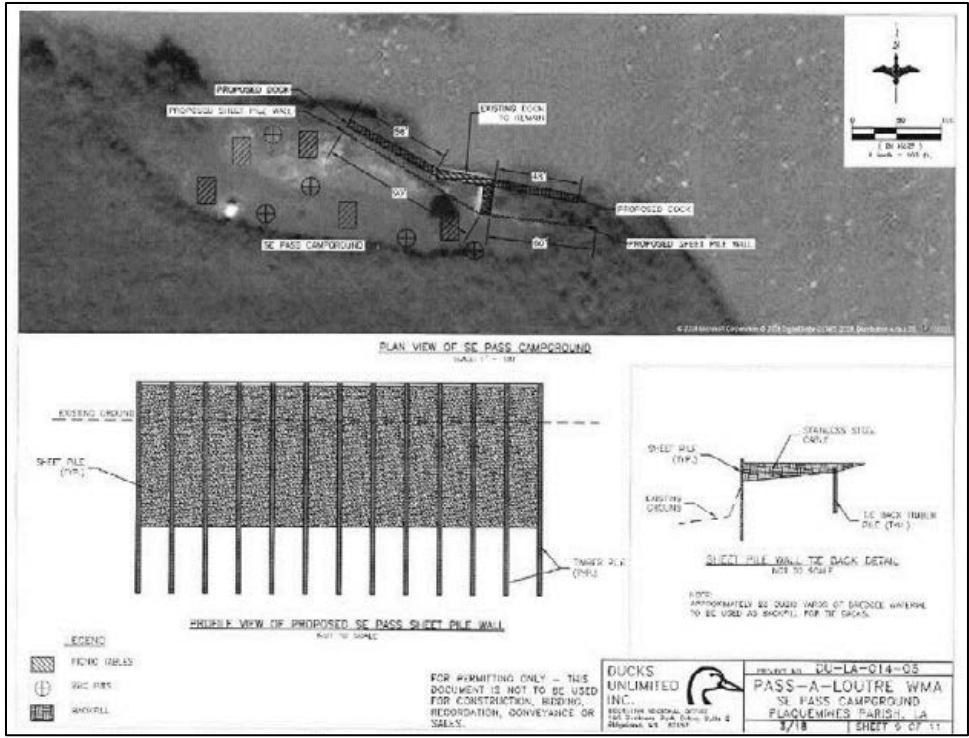

Figure E-2i. Pass-a-Loutre Wildlife Management Area Campgrounds.

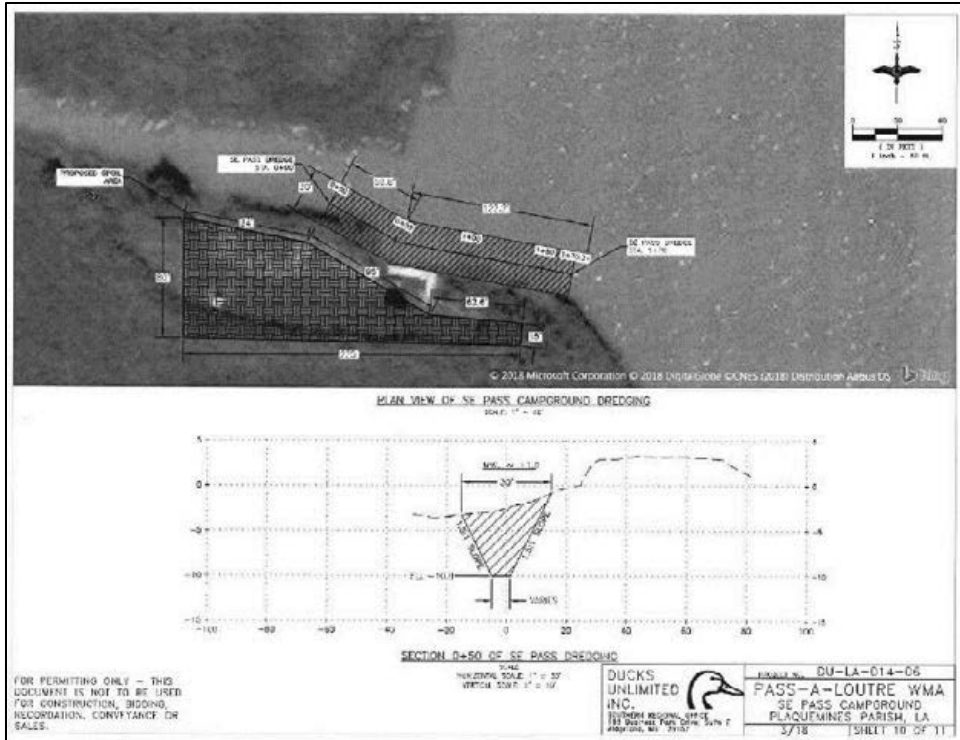

Figure E-2j. Pass-a-Loutre Wildlife Management Area Campgrounds.

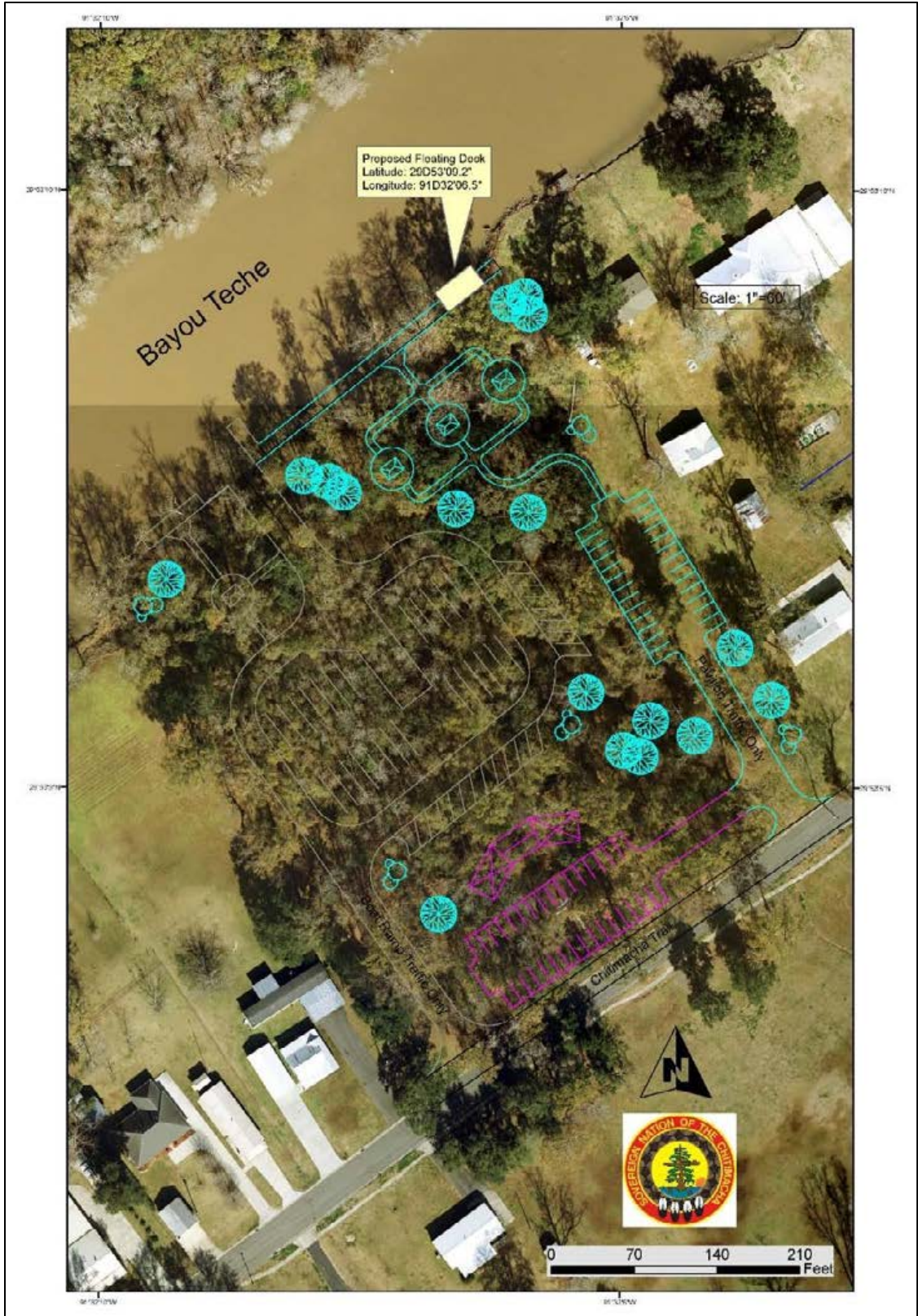
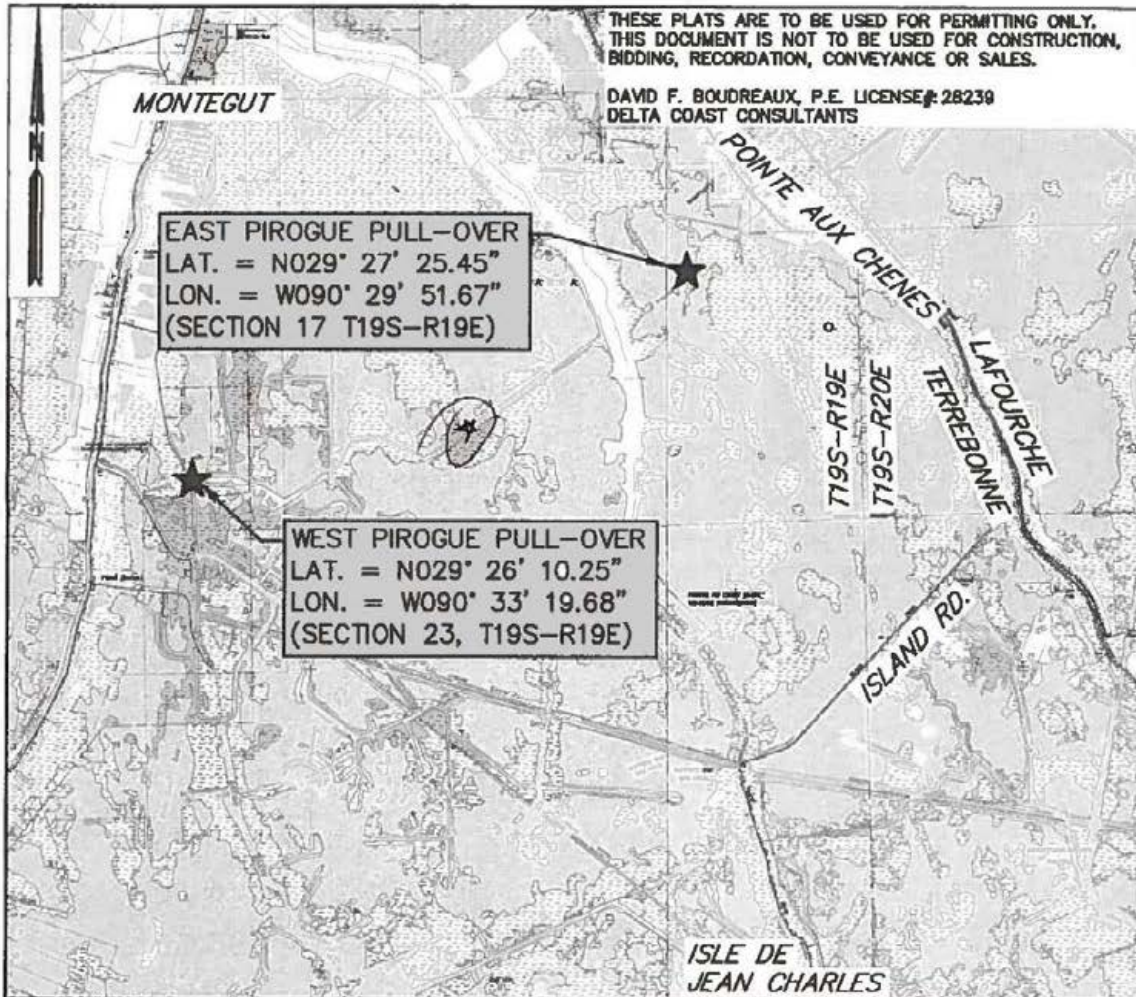

Figure E-3. Chitimacha Boat Launch.



SITE LOCATION MAP

SCALE: 1" = 2,000'

PROPOSED POINTE-AUX-CHENES PIROGUE PULL-OVERS TO BE INSTALLED ADJACENT TO THE MORGANZA TO THE GULF HURRICANE PROTECTION REACH J2 LEVEE NEAR MONTAGUE LOCATED IN SEC. 17, T19S-R19E & SEC. 23, T19S-R19E POINTE-AUX-CHENES, TERREBONNE PARISH, LOUISIANA

DELTA COAST CONSULTANTS, LLC
 4924 HWY 311 - HOUMA, LA 70360
 PHONE: 985-659-3100 www.deltacoastllc.com

APPLICANT: LOUISIANA DEPARTMENT OF WILDLIFE AND FISHERIES

DATE: 08/30/17
 PAGE 2 OF 7

FILE: P:\2017\2017.004\DWG\PRODUCTION\PERMIT DRAWINGS\PIROGUE PULL-OVERS\17004_PIROGUE PULL-OVER_VC_MAP.DWG

Figure E-4a. Pointe-aux-Chenes Wildlife Management Area Recreation Use Enhancement, pirogue pull-over.

THESE PLATS ARE TO BE USED FOR PERMITTING ONLY. THIS DOCUMENT IS NOT TO BE USED FOR CONSTRUCTION, BIDDING, RECORDATION, CONVEYANCE OR SALES.

DAVID F. BOUDREAU, P.E. LICENSE # 28239
DELTA COAST CONSULTANTS

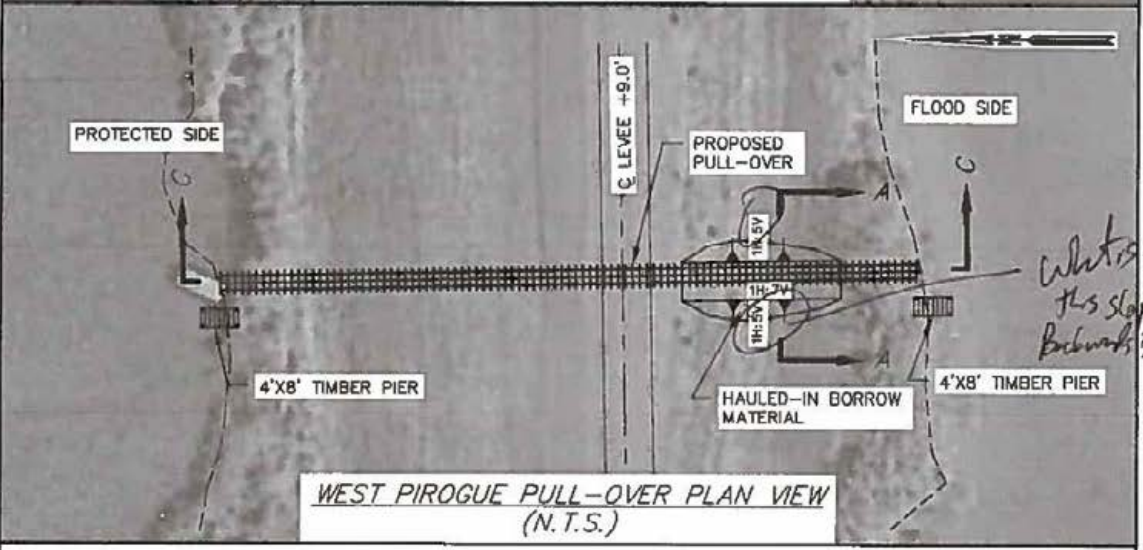
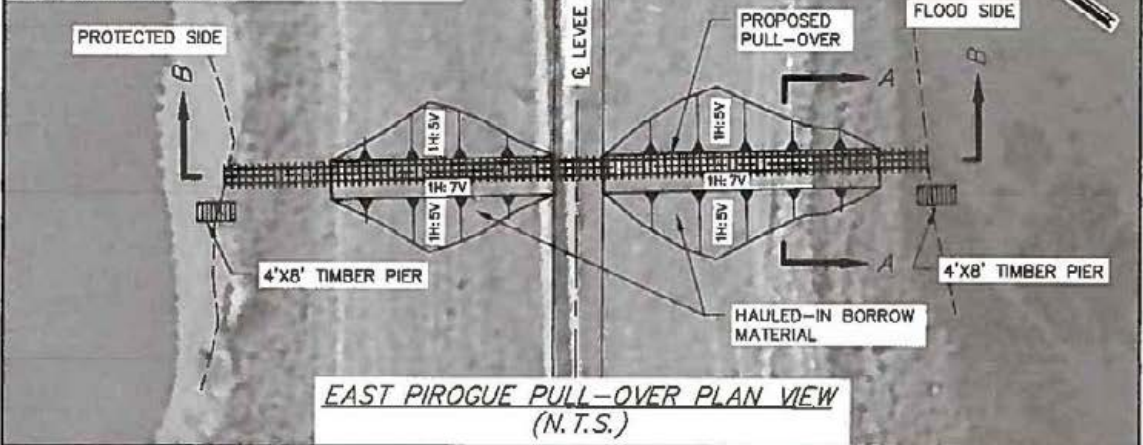

PLAN VIEW EAST AND WEST PIROGUE PULL-OVERS
PROPOSED POINTE-AUX-CHENES PIROGUE PULL-OVERS
TO BE INSTALLED ADJACENT TO THE MORGANZA TO THE GULF
HURRICANE PROTECTION REACH J2 LEVEE NEAR MONTAGUE.
LOCATED IN SEC. 17, T19S-R19E & SEC. 23, T19S-R19E
POINTE-AUX-CHENES, TERREBONNE PARISH, LOUISIANA

DELTA COAST CONSULTANTS, LLC
4924 HWY 311 - HOUMA, LA 70360
PHONE: 985-655-3100 www.deltacoastllc.com

APPLICANT: LOUISIANA DEPARTMENT OF WILDLIFE AND FISHERIES

DATE: 8/31/17
SHEET 3 OF 7

FILE: P:\2017\2017.004\DWG\PRODUCTION\PERMIT DRAWINGS\PIROGUE PULL-OVERS\17004_PIROGUE PULL-OVER.DWG

Figure E-4b. Pointe-aux-Chenes Wildlife Management Area Recreation Use Enhancement, pirogue pull-over.

EQUIPMENT LIST:
 1-EXCAVATOR
 1-BULLDOZER
 1-PILE DRIVING RIG
 PERSONNEL VEHICLES

THESE PLATS ARE TO BE USED FOR PERMITTING ONLY.
 THIS DOCUMENT IS NOT TO BE USED FOR CONSTRUCTION,
 BIDDING, RECORDATION, CONVEYANCE OR SALES.

DAVID F. BOUDREAU, P.E. LICENSE # 28239
 DELTA COAST CONSULTANTS

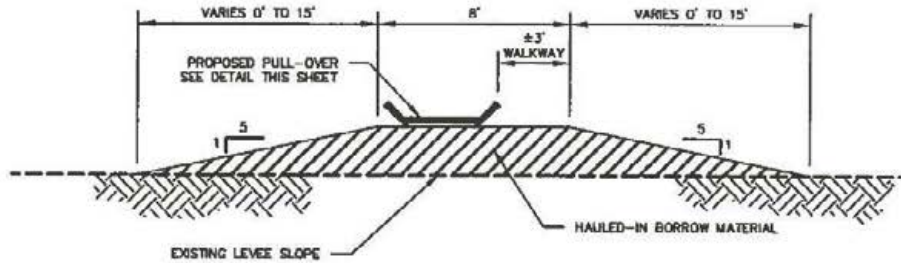

SECTION A-A
 (N.T.S.)

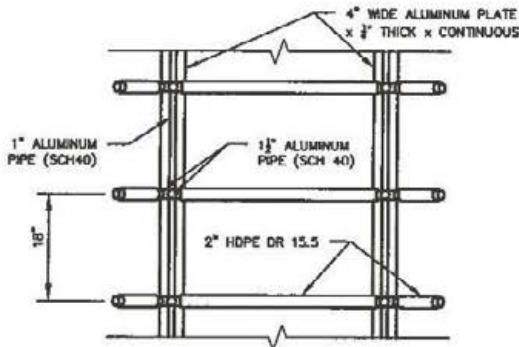

PULL-OVER PLAN DETAIL
 (N.T.S.)

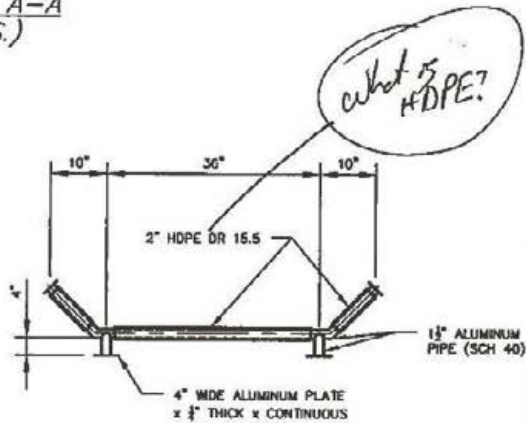

PULL-OVER SECTION DETAIL
 (N.T.S.)

CROSS-SECTION A-A AND DETAIL
 PROPOSED POINTE-AUX-CHENES PIROGUE PULL-OVERS
 TO BE INSTALLED ADJACENT TO THE MORGANZA TO THE GULF
 HURRICANE PROTECTION REACH J2 LEVEE NEAR MONTAGUE.
 LOCATED IN SEC. 17, T19S-R19E & SEC. 23, T19S-R19E
 POINTE-AUX-CHENES, TERREBONNE PARISH, LOUISIANA



APPLICANT: LOUISIANA DEPARTMENT OF
 WILDLIFE AND FISHERIES

DATE: 8/31/17
 SHEET 4 OF 7

FILE: P:\2017\2017.004\DWG\PRODUCTION\PERMIT DRAWINGS\PIROGUE PULL-OVERS\17004_PIROGUE PULL-OVER.DWG

Figure E-4c. Pointe-aux-Chenes Wildlife Management Area Recreation Use Enhancement, pirogue pull-over.

THESE PLATS ARE TO BE USED FOR PERMITTING ONLY. THIS DOCUMENT IS NOT TO BE USED FOR CONSTRUCTION, BIDDING, RECORDATION, CONVEYANCE OR SALES.

DAVID F. BOUDREAU, P.E. LICENSE # 28239
DELTA COAST CONSULTANTS

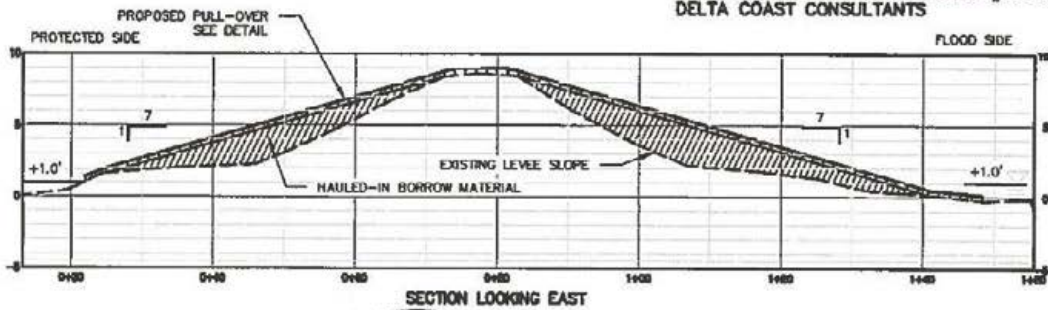

EAST PIROQUE PULL-OVER - SECTION B-B
(N.T.S.)

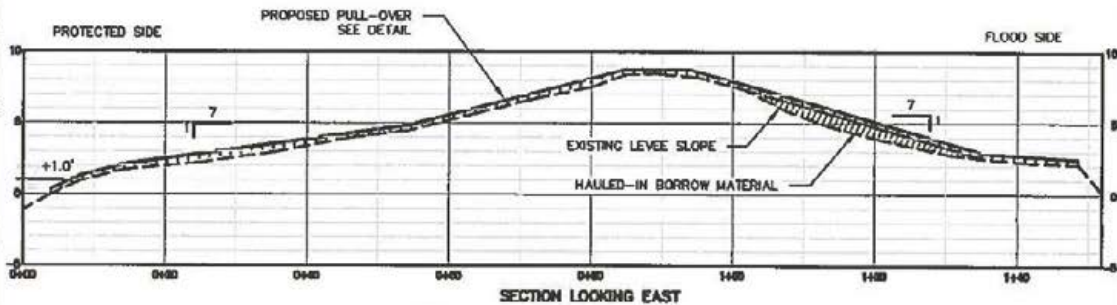

WEST PIROQUE PULL-OVER - SECTION C-C
(N.T.S.)

EAST AND WEST PIROQUE PULL-OVER CROSS SECTIONS
PROPOSED POINTE-AUX-CHENES PIROQUE PULL-OVERS
TO BE INSTALLED ADJACENT TO THE MORGANZA TO THE GULF
HURRICANE PROTECTION REACH J2 LEVEE NEAR MONTAGUE
LOCATED IN SEC. 17, T19S-R19E & SEC. 23, T19S-R19E
POINTE-AUX-CHENES, TERREBONNE PARISH, LOUISIANA



APPLICANT: LOUISIANA DEPARTMENT OF
WILDLIFE AND FISHERIES

DATE: 8/31/17
SHEET 5 OF 7

FILE: P:\2017\2017.004\DWG\PRODUCTION\PERMIT DRAWINGS\PIROQUE PULL-OVERS\17004_PIROQUE PULL-OVER.DWG

Figure E-4d. Pointe-aux-Chenes Wildlife Management Area Recreation Use Enhancement, piroque pull-over.

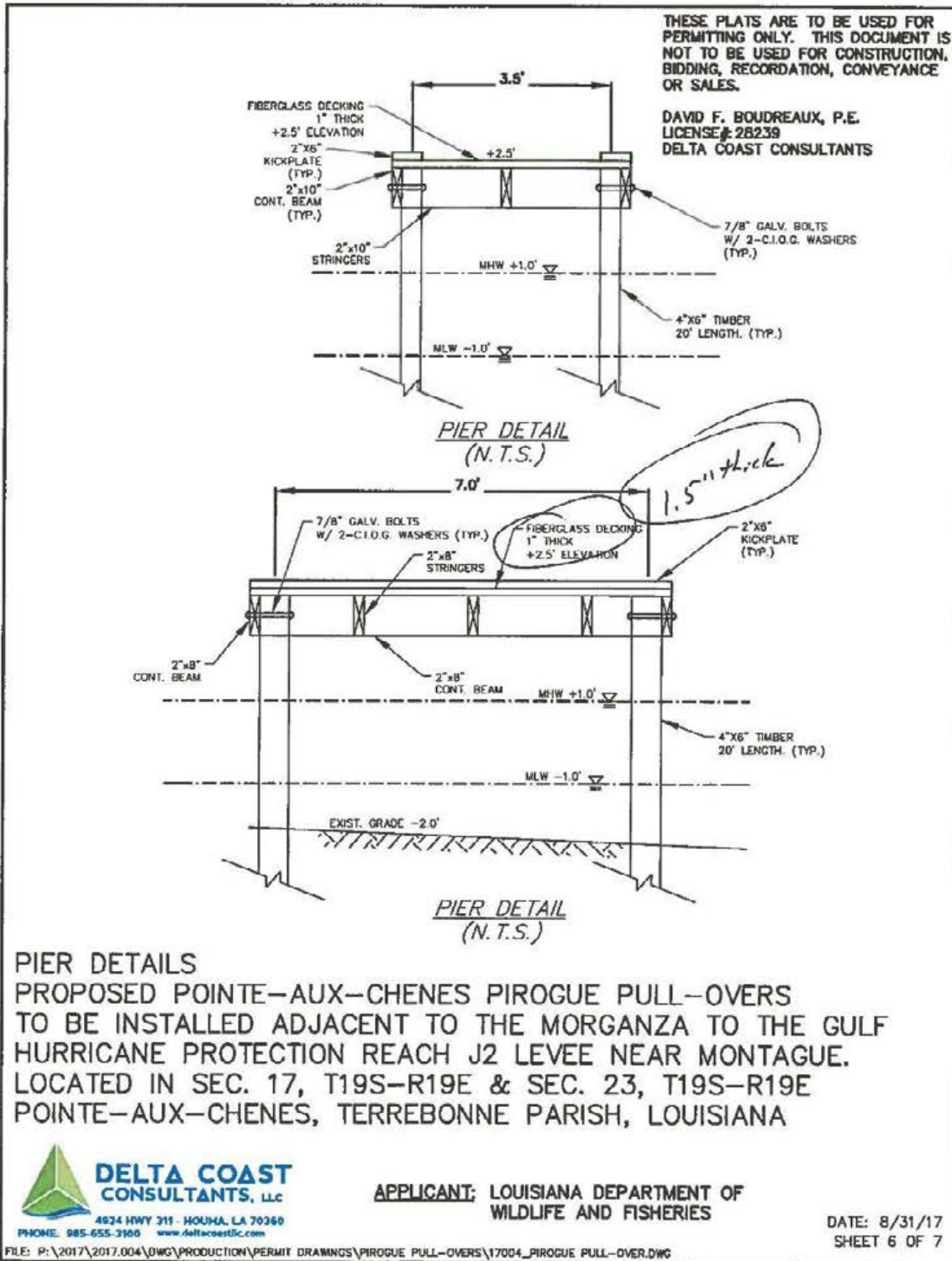

Figure E-4e. Pointe-aux-Chenes Wildlife Management Area Recreation Use Enhancement, pirogue pull-over.

THESE PLATS ARE TO BE USED FOR PERMITTING ONLY.
THIS DOCUMENT IS NOT TO BE USED FOR CONSTRUCTION,
BIDDING, RECORDATION, CONVEYANCE OR SALES.

DAVID F. BOUDREAU, P.E. LICENSE# 28239
DELTA COAST CONSULTANTS

NOTES:

1. ALL STRUCTURES, FACILITIES, WELLS AND PIPELINES/FLOWLINES OCCURRING IN OPEN WATER AREAS OR IN OILFIELD CANALS OR SLIPS SHALL BE REMOVED WITHIN 120 DAYS OF ABANDONMENT OF THE FACILITIES FOR THE HEREIN PERMITTED USE, UNLESS PRIOR WRITTEN APPROVAL TO LEAVE SUCH STRUCTURES IN PLACE IS RECEIVED FROM THE COASTAL MANAGEMENT DIVISION. THIS CONDITION DOES NOT PRECLUDE THE NECESSITY FOR REVISING THE CURRENT PERMIT OR OBTAINING A SEPARATE COASTAL USE PERMIT, SHOULD ONE BE REQUIRED, FOR SUCH REMOVAL ACTIVITIES.
2. AS-BUILT DRAWINGS SHALL BE SUBMITTED WITHIN 30 DAYS OF COMPLETION OF THIS PROJECT TO THE LOUISIANA DEPARTMENT OF NATURAL RESOURCES, COASTAL MANAGEMENT DIVISION, P.O. BOX 44487, BATON ROUGE, LA. 70804-4487.
3. STRUCTURES WILL BE MARKED/LIGHTED IN ACCORDANCE WITH U.S. COAST GUARD REGULATIONS.
4. IN ORDER TO ENSURE THE SAFETY OF ALL PARTIES, THE PERMITTEE SHALL CONTACT THE LOUISIANA ONE-CALL SYSTEM (1-800-272-3020) A MINIMUM OF 48 HOURS PRIOR TO THE COMMENCEMENT OF ANY EXCAVATION (DIGGING, DREDGING, JETTING, ETC.) OR DEMOLITION ACTIVITY.

QUANTITIES:

<u>STRUCTURE</u>	<u>HAULED IN BORROW MATERIAL</u>	<u>NO. OF PILES</u>
EAST PIROGUE PULLOVER	±291 C.Y.	8
WEST PIROGUE PULLOVER	±26 C.Y.	8

EQUIPMENT:

TUG BOAT
BARGE
CRANE
14' BOAT
LONG REACH EXCAVATOR

NOTES AND QUANTITIES

PROPOSED POINTE-AUX-CHENES PIROGUE PULL-OVERS
TO BE INSTALLED ADJACENT TO THE MORGANZA TO THE GULF
HURRICANE PROTECTION REACH J2 LEVEE NEAR MONTAGUE.
LOCATED IN SEC. 17, T19S-R19E & SEC. 23, T19S-R19E
POINTE-AUX-CHENES, TERREBONNE PARISH, LOUISIANA



APPLICANT: LOUISIANA DEPARTMENT OF
WILDLIFE AND FISHERIES

DATE: 8/31/17
SHEET 7 OF 7

FILE: P:\2017\2017.004\DWG\PRODUCTION\PERMIT DRAWINGS\PIROGUE PULL-OVERS\17004_PIROGUE PULL-OVER.DWG

Figure E-4f. Pointe-aux-Chenes Wildlife Management Area Recreation Use Enhancement, pirogue pull-over.

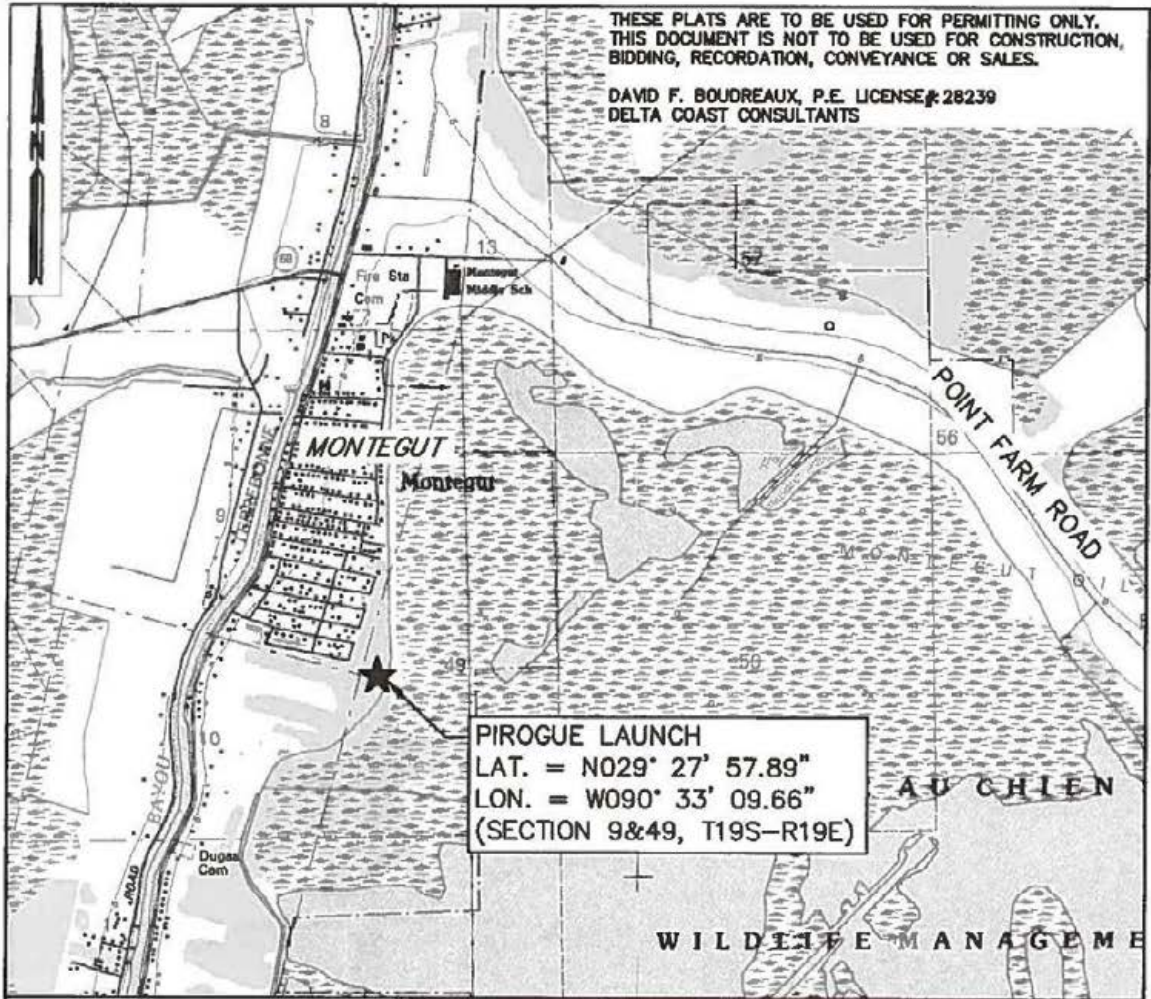

SITE LOCATION MAP

SCALE: 1" = 2,000'

PROPOSED POINTE-AUX-CHENES PIROGUE LAUNCH
TO BE INSTALLED AT END OF WILDERNESS ST.
LOCATED IN SEC. 9, T18S-R19E & SEC. 49, T18S-R19E
MONTEGUT, TERREBONNE PARISH, LOUISIANA



APPLICANT: LOUISIANA DEPARTMENT
OF WILDLIFE AND FISHERIES

DATE: 10/4/17
PAGE 2 OF 10

FILE: P:\2017\2017.004\DWG\PRODUCTION\PERMIT DRAWINGS\PIROGUE LAUNCH\17004_PIROGUE LAUNCH_MC_MAP.DWG

Figure E-5a. Pointe-aux-Chenes Wildlife Management Area Recreation Use Enhancement, pirogue launch.

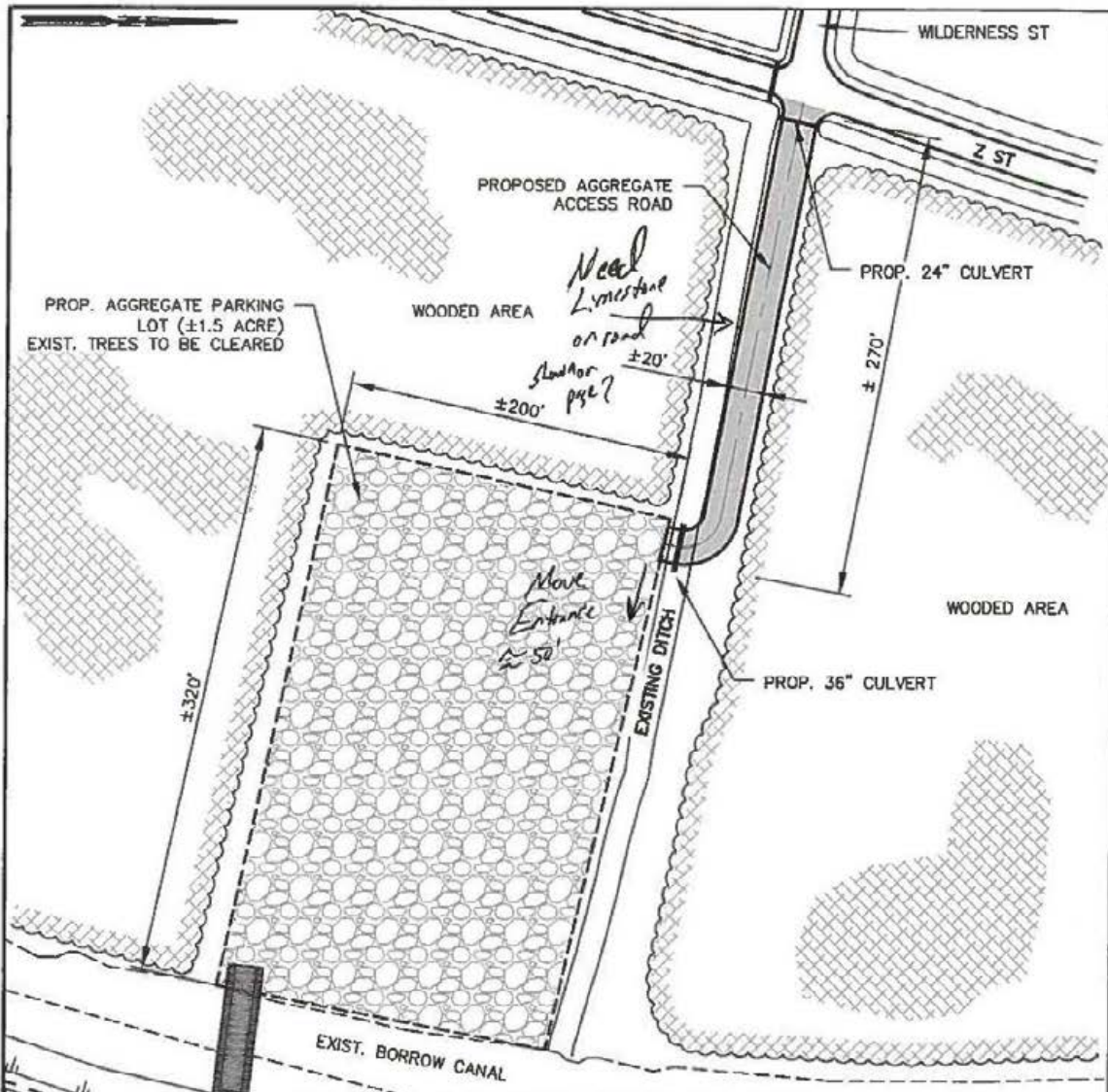

ROAD & PARKING LOT PLAN VIEW
SCALE: 1" = 80'

PROPOSED POINTE-AUX-CHENES PIROGUE LAUNCH
TO BE INSTALLED AT END OF WILDERNESS ST.
LOCATED IN SEC. 9, T18S-R19E & SEC. 49, T18S-R19E
MONTEGUT, TERREBONNE PARISH, LOUISIANA

 **DELTA COAST CONSULTANTS, LLC**
4924 HWY 311 - HOUHA, LA 70360
PHONE: 985-655-3100 www.deltacoastllc.com

APPLICANT: LOUISIANA DEPARTMENT OF WILDLIFE AND FISHERIES

DATE: 10/4/17
SHEET 4 OF 10

FILE: P:\2017\2017.004\DWG\PRODUCTION\PERMIT DRAWINGS\PIROGUE LAUNCH\17004_PIROGUE LAUNCH_PLAN.DWG

Figure E-5b. Pointe-aux-Chenes Wildlife Management Area Recreation Use Enhancement, pirogue launch.

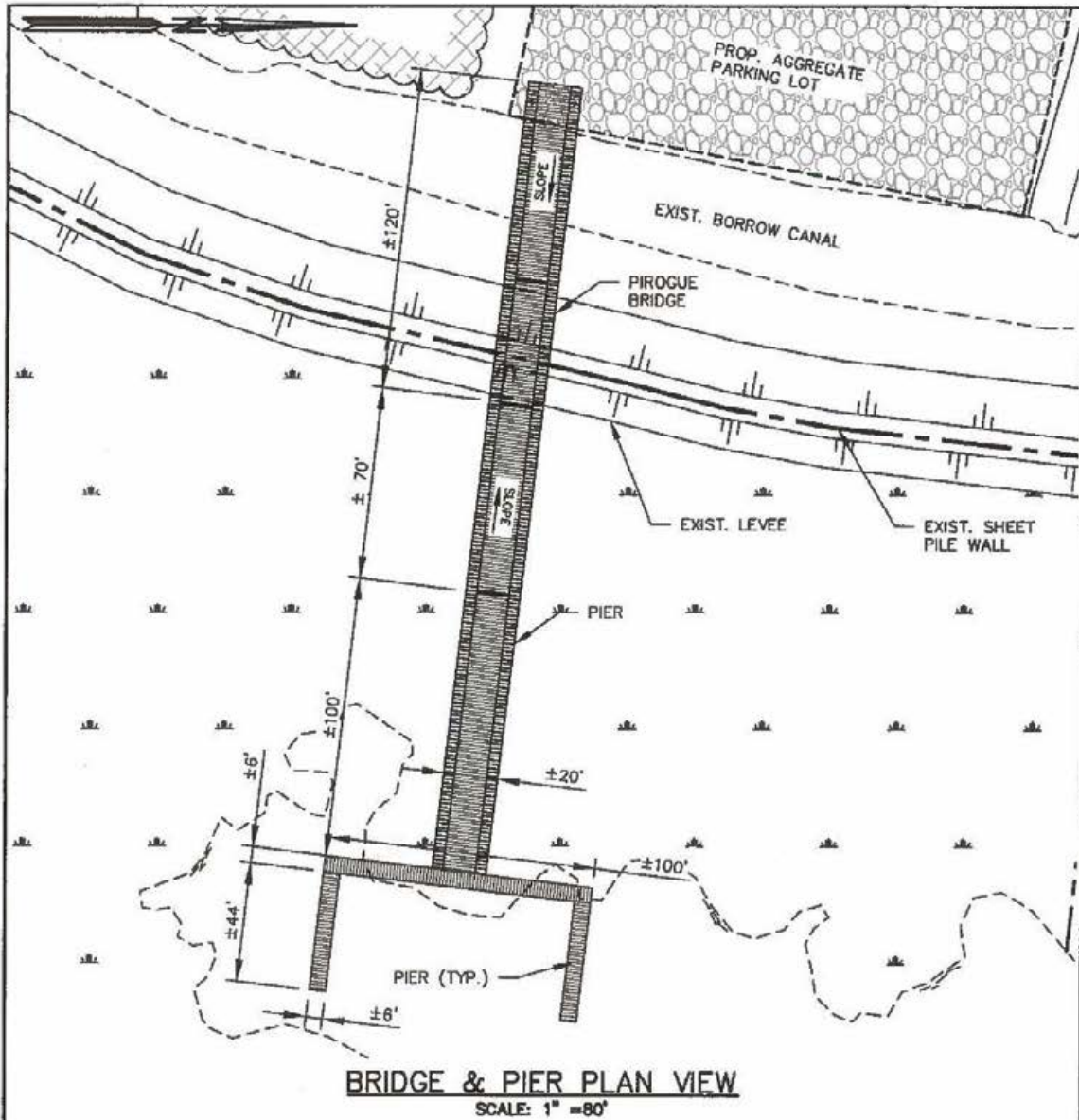

PROPOSED POINTE-AUX-CHENES PIROGUE LAUNCH
 TO BE INSTALLED AT END OF WILDERNESS ST.
 LOCATED IN SEC. 9, T18S-R19E & SEC. 49, T18S-R19E
 MONTEGUT, TERREBONNE PARISH, LOUISIANA

DELTA COAST CONSULTANTS, LLC
 4924 HWY 311 - HOUMA, LA 70360
 PHONE: 985-855-3100 www.deltacoastllc.com

APPLICANT: LOUISIANA DEPARTMENT OF WILDLIFE AND FISHERIES

DATE: 10/4/17
 SHEET 5 OF 10

FILE: P:\2017\2017.004\DWG\PRODUCTION\PERMIT DRAWINGS\PIROGUE LAUNCH\17004_PIROGUE LAUNCH_PLAN.DWG

Figure E-5c. Pointe-aux-Chenes Wildlife Management Area Recreation Use Enhancement, pirogue launch.

*Wilderness St
 Montegut
 11/1/17*

THESE PLATS ARE TO BE USED FOR PERMITTING ONLY.
 THIS DOCUMENT IS NOT TO BE USED FOR CONSTRUCTION,
 BIDDING, RECORDATION, CONVEYANCE OR SALES.

DAVID F. BOUDREAU, P.E. LICENSE # 28239
 DELTA COAST CONSULTANTS

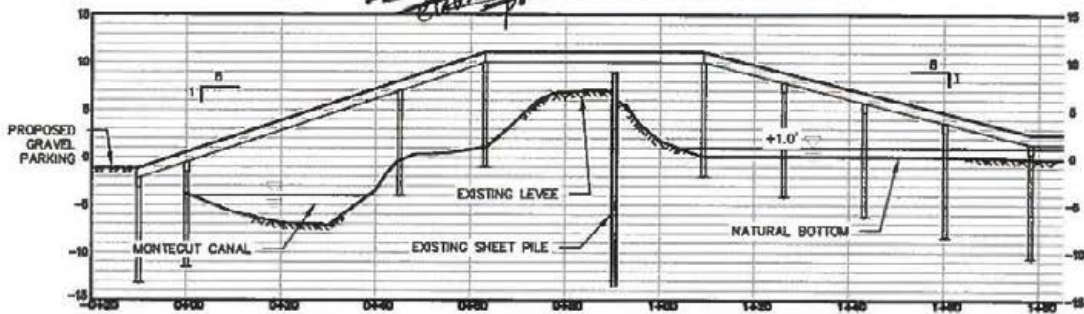

SECTION A-A
 (N.T.S.)

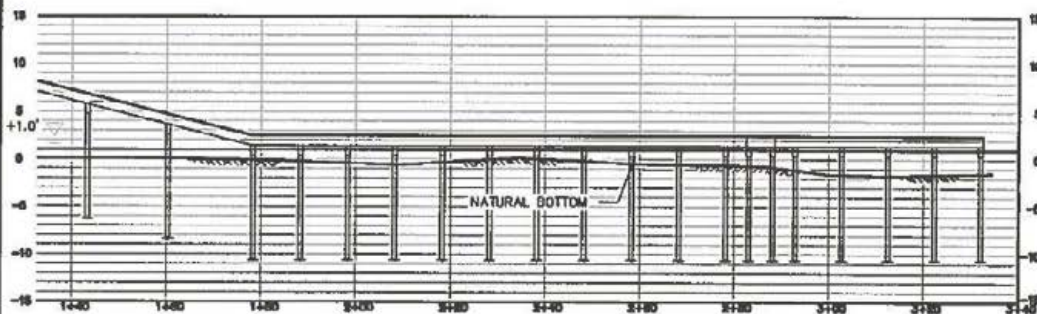

SECTION A-A (CONT.)
 (N.T.S.)

PROPOSED POINTE-AUX-CHENES PIROGUE LAUNCH
 TO BE INSTALLED AT END OF WILDERNESS ST.
 LOCATED IN SEC. 9, T18S-R19E & SEC. 49, T18S-R19E
 MONTEGUT, TERREBONNE PARISH, LOUISIANA



APPLICANT: LOUISIANA DEPARTMENT OF WILDLIFE AND FISHERIES

DATE: 10/4/17
 SHEET 6 OF 10

FILE: P:\2017\2017.004\DWG\PRODUCTION\PERMIT DRAWINGS\PIROGUE LAUNCH\17004_PIROGUE LAUNCH SECTIONS2.DWG

Figure E-5d. Pointe-aux-Chenes Wildlife Management Area Recreation Use Enhancement, pirogue launch.

THESE PLATS ARE TO BE USED FOR PERMITTING ONLY. THIS DOCUMENT IS NOT TO BE USED FOR CONSTRUCTION, BIDDING, RECORDATION, CONVEYANCE OR SALES.

DAVID F. BOUDREAU, P.E. LICENSE # 28239
DELTA COAST CONSULTANTS

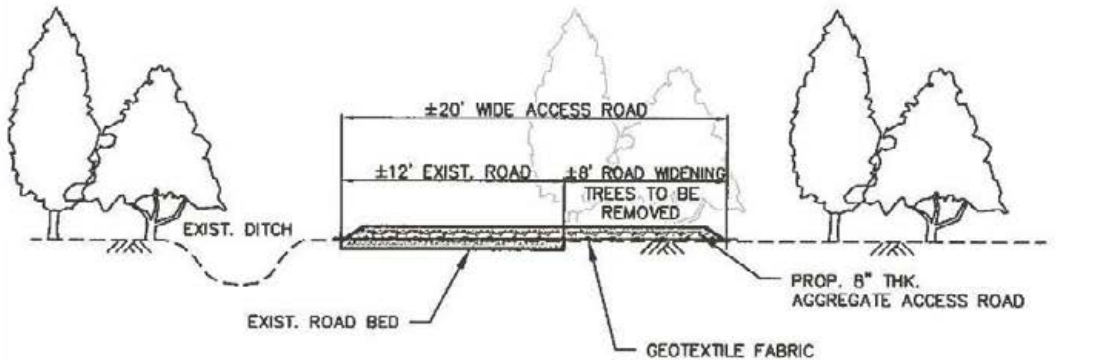

*SECTION THRU ACCESS ROAD
(N.T.S.)*

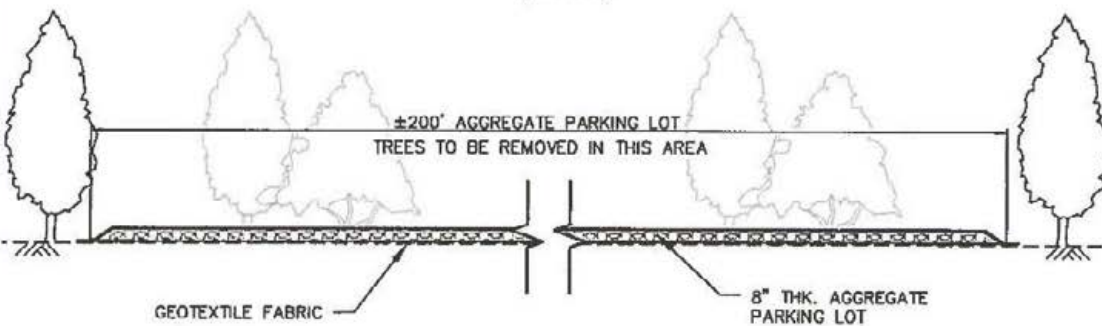

*SECTION THRU PARKING LOT
(N.T.S.)*

PROPOSED POINTE-AUX-CHENES PIROGUE LAUNCH
TO BE INSTALLED AT END OF WILDERNESS ST.
LOCATED IN SEC. 9, T18S-R19E & SEC. 49, T18S-R19E
MONTEGUT, TERREBONNE PARISH, LOUISIANA



APPLICANT: LOUISIANA DEPARTMENT OF
WILDLIFE AND FISHERIES

DATE: 10/4/17
SHEET 7 OF 10

FILE: P:\2017\2017.004\DWG\PRODUCTION\PERMIT DRAWINGS\PIROGUE LAUNCH\17004_PIROGUE LAUNCH SECTIONS2.DWG

Figure E-5e. Pointe-aux-Chenes Wildlife Management Area Recreation Use Enhancement, pirogue launch.

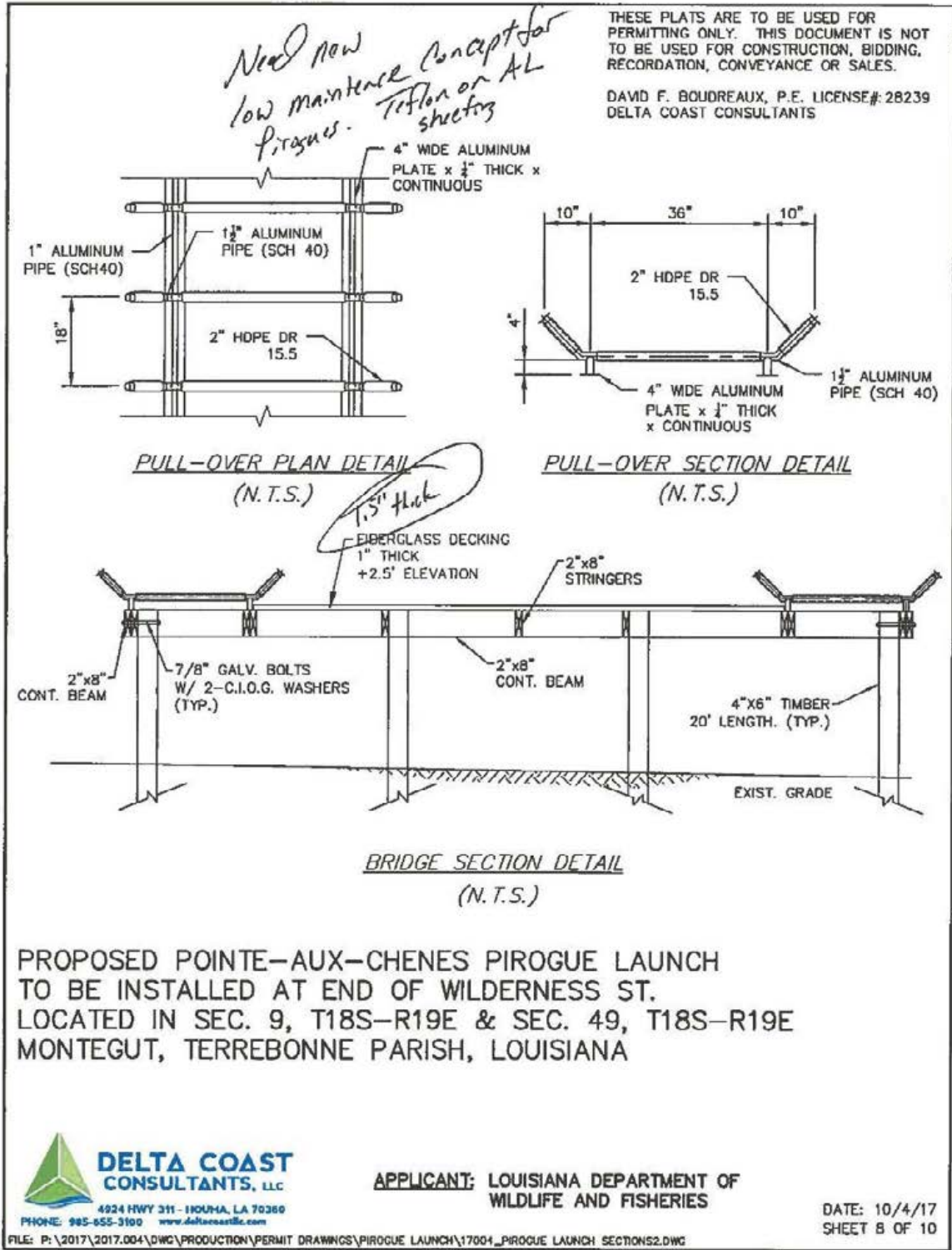
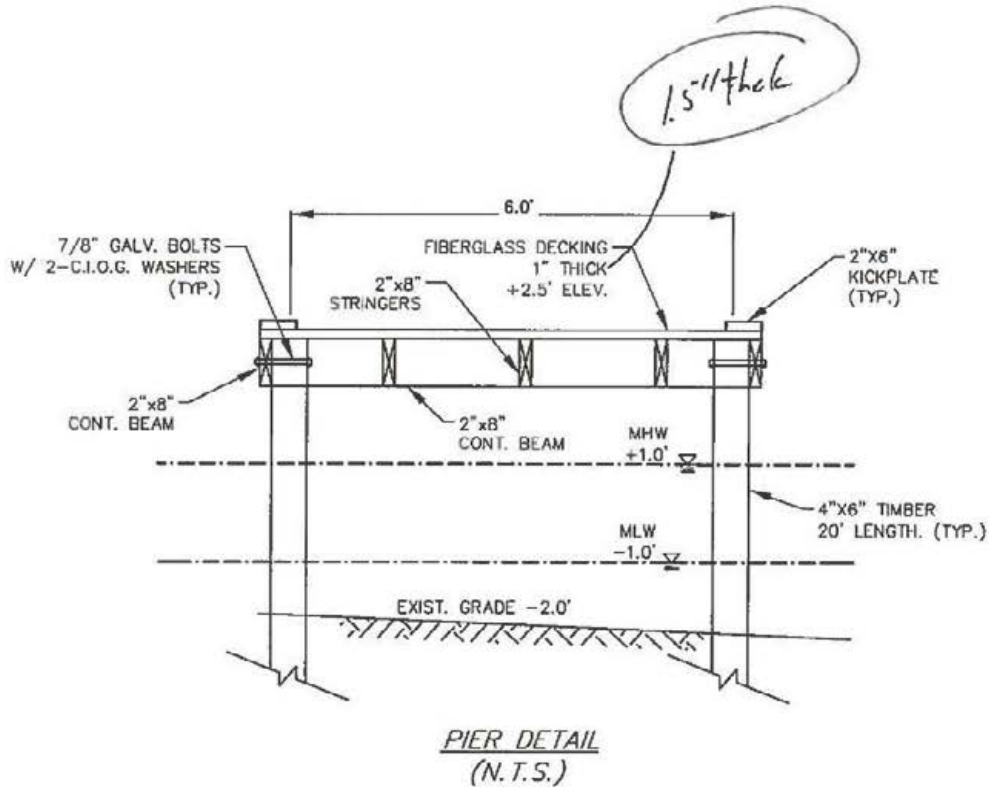

Figure E-5f. Pointe-aux-Chenes Wildlife Management Area Recreation Use Enhancement, pirogue launch.

THESE PLATS ARE TO BE USED FOR PERMITTING ONLY. THIS DOCUMENT IS NOT TO BE USED FOR CONSTRUCTION, BIDDING, RECORDATION, CONVEYANCE OR SALES.

DAVID F. BOUDREAU, P.E. LICENSE#: 28239
DELTA COAST CONSULTANTS



PROPOSED POINTE-AUX-CHENES PIROGUE LAUNCH
TO BE INSTALLED AT END OF WILDERNESS ST.
LOCATED IN SEC. 9, T18S-R19E & SEC. 49, T18S-R19E
MONTEGUT, TERREBONNE PARISH, LOUISIANA



APPLICANT: LOUISIANA DEPARTMENT OF
WILDLIFE AND FISHERIES

DATE: 10/4/17
SHEET 9 OF 10

FILE: P:\2017\2017.004\DWG\PRODUCTION\PERMIT DRAWINGS\PIROGUE LAUNCH\17004_PIROGUE LAUNCH SECTIONS2.DWG

Figure E-5g. Pointe-aux-Chenes Wildlife Management Area Recreation Use Enhancement, pirogue launch.

THESE PLATS ARE TO BE USED FOR PERMITTING ONLY.
THIS DOCUMENT IS NOT TO BE USED FOR CONSTRUCTION,
BIDDING, RECORDATION, CONVEYANCE OR SALES.

DAVID F. BOUDREAU, P.E. LICENSE # 28239
DELTA COAST CONSULTANTS

NOTES:

1. ALL STRUCTURES, FACILITIES, WELLS AND PIPELINES/FLOWLINES OCCURRING IN OPEN WATER AREAS OR IN OILFIELD CANALS OR SLIPS SHALL BE REMOVED WITHIN 120 DAYS OF ABANDONMENT OF THE FACILITIES FOR THE HEREIN PERMITTED USE, UNLESS PRIOR WRITTEN APPROVAL TO LEAVE SUCH STRUCTURES IN PLACE IS RECEIVED FROM THE COASTAL MANAGEMENT DIVISION. THIS CONDITION DOES NOT PRECLUDE THE NECESSITY FOR REVISING THE CURRENT PERMIT OR OBTAINING A SEPARATE COASTAL USE PERMIT, SHOULD ONE BE REQUIRED, FOR SUCH REMOVAL ACTIVITIES.
2. AS-BUILT DRAWINGS SHALL BE SUBMITTED WITHIN 30 DAYS OF COMPLETION OF THIS PROJECT TO THE LOUISIANA DEPARTMENT OF NATURAL RESOURCES, COASTAL MANAGEMENT DIVISION, P.O. BOX 44487. BATON ROUGE, LA. 70804-4487.
3. STRUCTURES WILL BE MARKED/LIGHTED IN ACCORDANCE WITH U.S. COAST GUARD REGULATIONS.
4. IN ORDER TO ENSURE THE SAFETY OF ALL PARTIES, THE PERMITTEE SHALL CONTACT THE LOUISIANA ONE-CALL SYSTEM (1-800-272-3020) A MINIMUM OF 48 HOURS PRIOR TO THE COMMENCEMENT OF ANY EXCAVATION (DIGGING, DREDGING, JETTING, ETC.) OR DEMOLITION ACTIVITY.

PROPOSED POINTE-AUX-CHENES PIROGUE LAUNCH
TO BE INSTALLED AT END OF WILDERNESS ST.
LOCATED IN SEC. 9, T18S-R19E & SEC. 49, T18S-R19E
MONTEGUT, TERREBONNE PARISH, LOUISIANA



APPLICANT: LOUISIANA DEPARTMENT OF
WILDLIFE AND FISHERIES

DATE: 10/4/17
SHEET 10 OF 10

FILE: P:\2017\2017.004\DWG\PRODUCTION\PERMIT DRAWINGS\PIROGUE LAUNCH\17004_PIROGUE LAUNCH SECTIONS2.DWG

Figure E-5h. Pointe-aux-Chenes Wildlife Management Area Recreation Use Enhancement, pirogue launch.

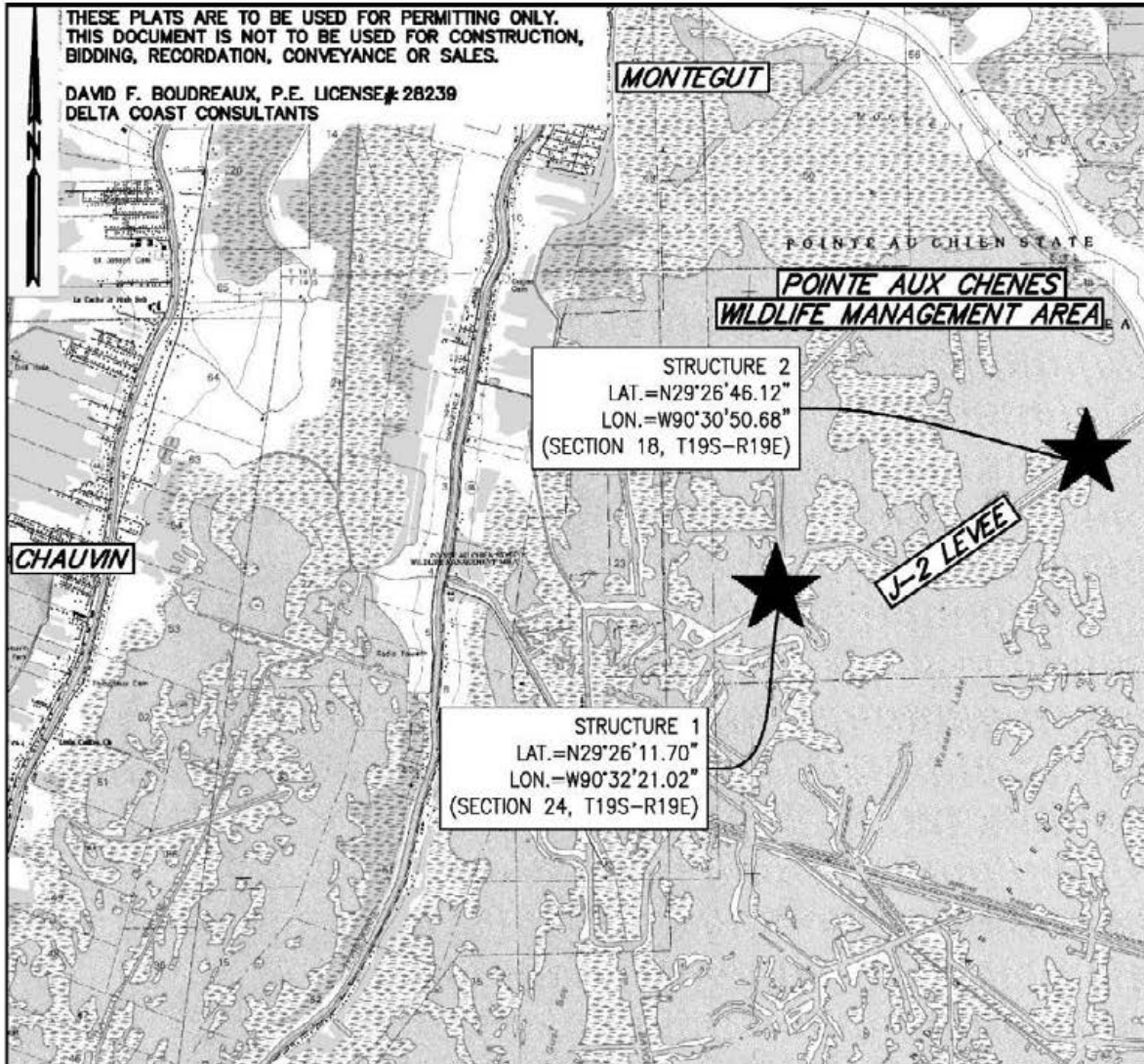

OVERALL VICINITY MAP

SCALE: 1" = 4,000'

PROPOSED FISHING PIERS
TO BE INSTALLED ON THE J-2 STRUCTURES. LOCATED IN SEC.
24, T19S-R19E & SEC. 18, T19S-R19E
POINTE-AUX-CHENES, TERREBONNE PARISH, LOUISIANA



**DELTA COAST
CONSULTANTS, LLC**

4924 HWY 311 - HOUMA, LA 70360
PHONE: 985-655-3100 www.deltacoastllc.com

APPLICANT: LOUISIANA DEPARTMENT
OF WILDLIFE AND FISHERIES

DATE: 11/16/17
PAGE 1 OF 8

FILE: P:\2017\2017.004\DWG\PRODUCTION\PERMIT DRAWINGS\PHASE 01 DOCKS ON J-2 STRUCTURES\2017.004_PIER-S-DOCKS ON J-2 STRUCTURES_VCMAP.DWG

Figure E-6a. Pointe-aux-Chenes Wildlife Management Area Recreation Use Enhancement, access improvements.

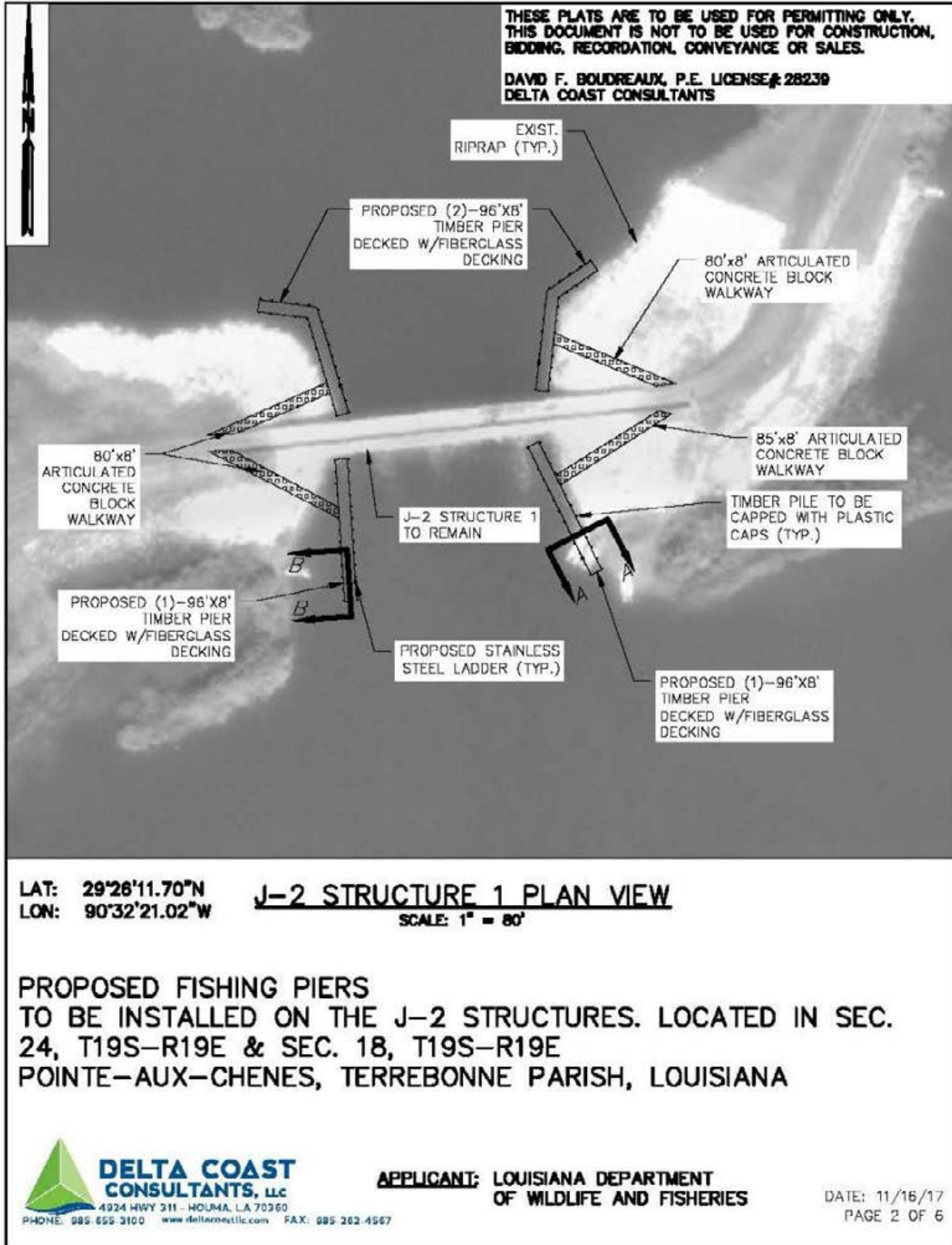

Figure E-6b. Pointe-aux-Chenes Wildlife Management Area Recreation Use Enhancement, access improvements.

C

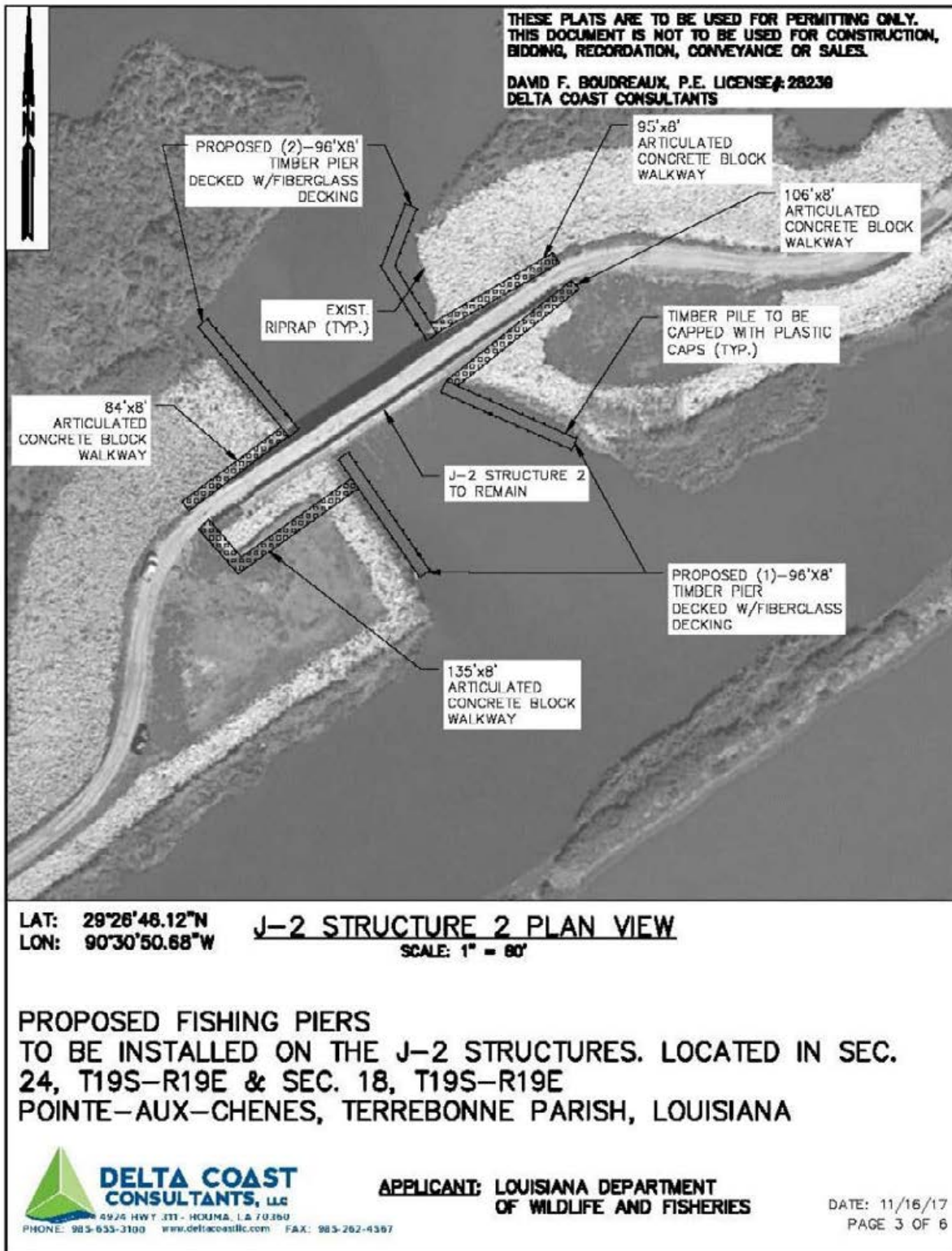
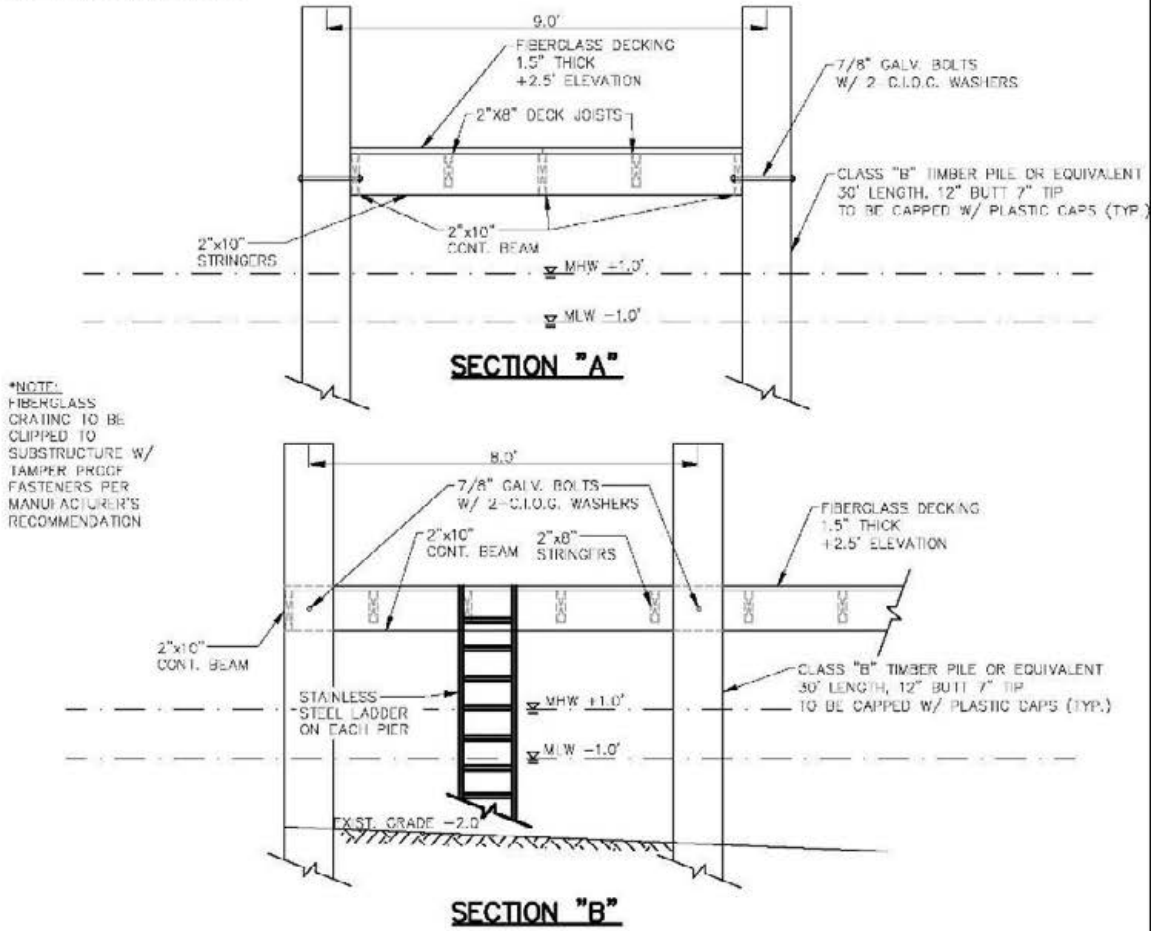

Figure E-6c. Pointe-aux-Chenes Wildlife Management Area Recreation Use Enhancement, access improvements.

THESE PLATS ARE TO BE USED FOR PERMITTING ONLY.
THIS DOCUMENT IS NOT TO BE USED FOR CONSTRUCTION,
BIDDING, RECORDATION, CONVEYANCE OR SALES.

DAVID F. BOUDREAUX, P.E. LICENSE # 28239
DELTA COAST CONSULTANTS



*NOTE:
FIBERGLASS
CRATING TO BE
CLIPPED TO
SUBSTRUCTURE W/
TAMPER PROOF
FASTENERS PER
MANUFACTURER'S
RECOMMENDATION

TYPICAL SECTION VIEWS
NOT TO SCALE

PROPOSED FISHING PIERS
TO BE INSTALLED ON THE J-2 STRUCTURES. LOCATED IN SEC.
24, T19S-R19E & SEC. 18, T19S-R19E
POINTE-AUX-CHENES, TERREBONNE PARISH, LOUISIANA

**DELTA COAST
CONSULTANTS, LLC**
4924 HWY 311 - HOUMA, LA 70360
PHONE: 985-655-3100 www.deltacoastllc.com

APPLICANT: LOUISIANA DEPARTMENT
OF WILDLIFE AND FISHERIES

DATE: 11/16/17
PAGE 4 OF 6

FILE: P:\2017\2017.004\DWG\PRODUCTION\PERMIT DRAWINGS\PHASE 01 DOCKS ON J-2 STRUCTURES\2017.004_PIER-S DOCKS ON J-2 STRUCTURES_SECTIONS.DWG

Figure E-6d. Pointe-aux-Chenes Wildlife Management Area Recreation Use Enhancement, access improvements.

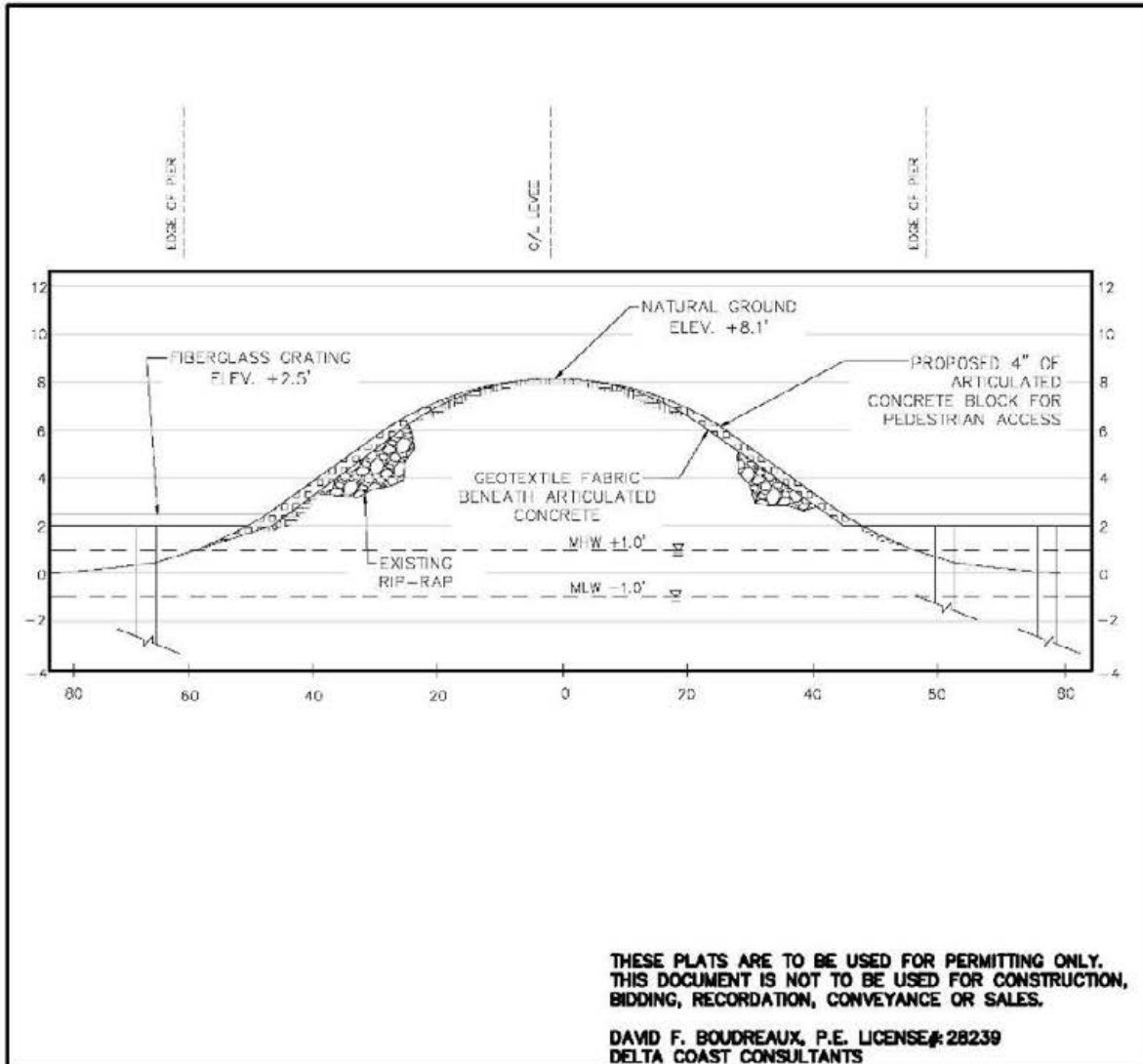

TYPICAL LEVEE SECTION
NOT TO SCALE

PROPOSED FISHING PIERS
TO BE INSTALLED ON THE J-2 STRUCTURES. LOCATED IN SEC.
24, T19S-R19E & SEC. 18, T19S-R19E
POINTE-AUX-CHENES, TERREBONNE PARISH, LOUISIANA



APPLICANT: LOUISIANA DEPARTMENT
OF WILDLIFE AND FISHERIES

DATE: 11/16/17
PAGE 5 OF 6

FILE: P:\2017\2017.004\DWG\PRODUCTION\PERMIT DRAWINGS\PHASE 01 DOCKS ON J-2 STRUCTURES\2017.004_PIER-S-DOCKS ON J-2 STRUCTURES_SECTIONS.DWG

Figure E-6e. Pointe-aux-Chenes Wildlife Management Area Recreation Use Enhancement, access improvements.

THESE PLATS ARE TO BE USED FOR PERMITTING ONLY.
THIS DOCUMENT IS NOT TO BE USED FOR CONSTRUCTION,
BIDDING, RECORDATION, CONVEYANCE OR SALES.

DAVID F. BOUDREAUX, P.E. LICENSE # 28239
DELTA COAST CONSULTANTS

NOTES:

1. ALL STRUCTURES, FACILITIES, WELLS AND PIPELINES/FLOWLINES OCCURRING IN OPEN WATER AREAS OR IN OILFIELD CANALS OR SLIPS SHALL BE REMOVED WITHIN 120 DAYS OF ABANDONMENT OF THE FACILITIES FOR THE HEREIN PERMITTED USE, UNLESS PRIOR WRITTEN APPROVAL TO LEAVE SUCH STRUCTURES IN PLACE IS RECEIVED FROM THE COASTAL MANAGEMENT DIVISION. THIS CONDITION DOES NOT PRECLUDE THE NECESSITY FOR REVISING THE CURRENT PERMIT OR OBTAINING A SEPARATE COASTAL USE PERMIT, SHOULD ONE BE REQUIRED, FOR SUCH REMOVAL ACTIVITIES.
2. AS-BUILT DRAWINGS SHALL BE SUBMITTED WITHIN 30 DAYS OF COMPLETION OF THIS PROJECT TO THE LOUISIANA DEPARTMENT OF NATURAL RESOURCES, COASTAL MANAGEMENT DIVISION, P.O. BOX 44487, BATON ROUGE, LA. 70804-4487.
3. STRUCTURES WILL BE MARKED/LIGHTED IN ACCORDANCE WITH U.S. COAST GUARD REGULATIONS.
4. IN ORDER TO ENSURE THE SAFETY OF ALL PARTIES, THE PERMITTEE SHALL CONTACT THE LOUISIANA ONE-CALL SYSTEM (1-800-272-3020) A MINIMUM OF 48 HOURS PRIOR TO THE COMMENCEMENT OF ANY EXCAVATION (DIGGING, DREDGING, JETTING, ETC.) OR DEMOLITION ACTIVITY.

QUANTITIES:

	<u>ARTICULATED CONCRETE</u>	<u>NO. OF PILES</u>
STRUCTURE 1	257 S.Y.	112
STRUCTURE 2	365 S.Y.	112

EQUIPMENT:

1. TUG BOAT
2. BARGE
3. CRANE
4. 14' BOAT
5. LONG REACH EXCAVATOR

NOTES AND QUANTITIES

PROPOSED FISHING PIERS
TO BE INSTALLED ON THE J-2 STRUCTURES. LOCATED IN SEC.
24, T19S-R19E & SEC. 18, T19S-R19E
POINTE-AUX-CHENES, TERREBONNE PARISH, LOUISIANA



APPLICANT: LOUISIANA DEPARTMENT
OF WILDLIFE AND FISHERIES

DATE: 11/16/17
PAGE 6 OF 6

FILE: P:\2017\2017.004\DWG\PRODUCTION\PERMIT DRAWINGS\PHASE 01 DOCKS ON J-2 STRUCTURES\2017.004_PIER-S DOCKS ON J-2 STRUCTURES_SECTIONS.DWG

Figure E-6f. Pointe-aux-Chenes Wildlife Management Area Recreation Use Enhancement, access improvements.

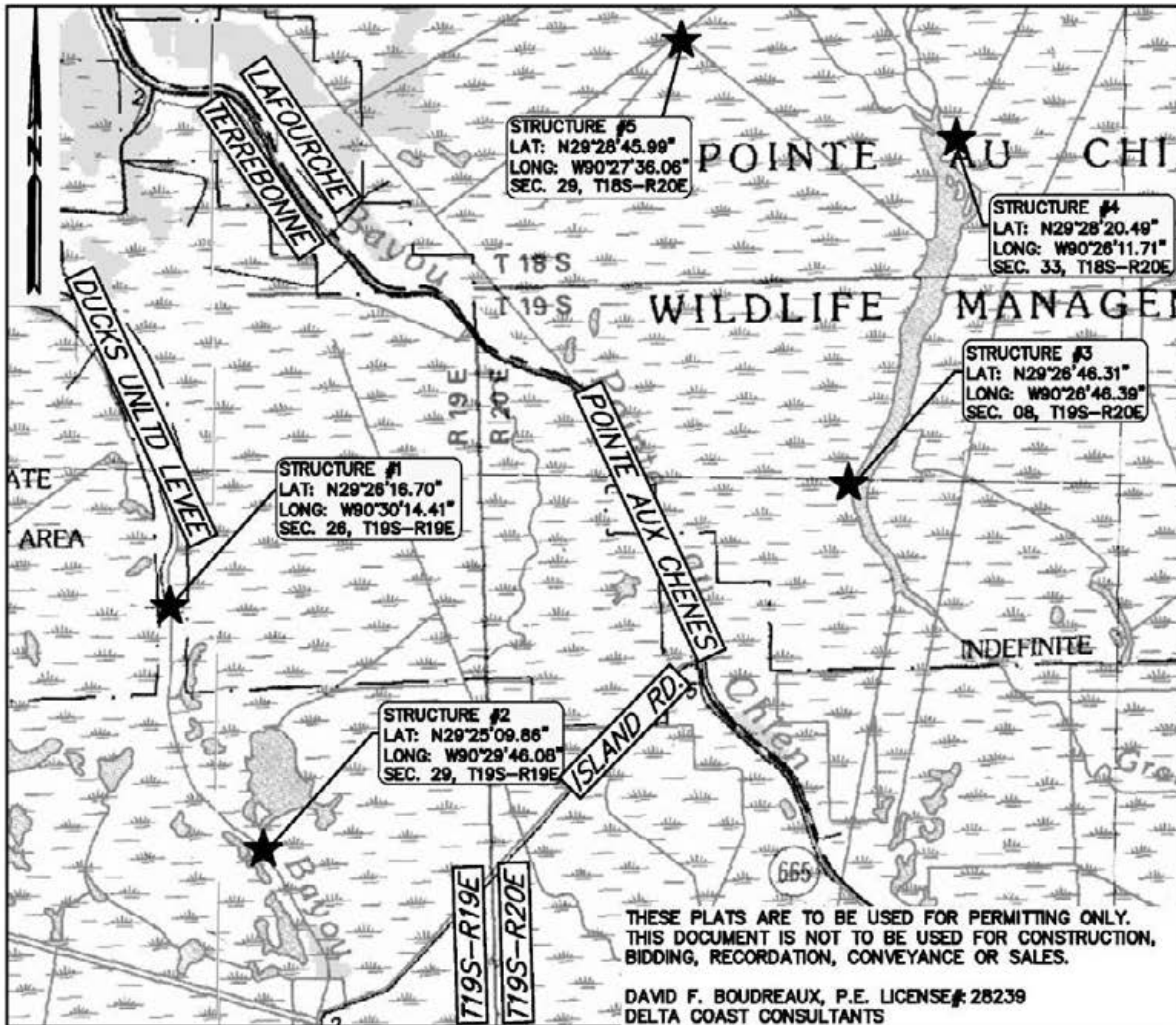

SITE LOCATION MAP

SCALE: 1" = 4,000'

PROPOSED FISHING PIERS/DOCKS TO BE CONSTRUCTED
IN GRAND BAYOU & SONGE WILDLIFE MANAGEMENT AREAS
LOCATED IN SEC. 26&29, T19S-R19E, SEC. 08, T19S-R20E, &
SEC. 33&29, T18S-R20E
POINTE-AUX-CHENES, TERREBONNE & LAFOURCHE PARISHES,
LOUISIANA

**DELTA COAST
CONSULTANTS, LLC**
4924 HWY 311 - HOUMA, LA 70360
PHONE: 985-655-3100 www.deltacoastllc.com

APPLICANT: LOUISIANA DEPARTMENT
OF WILDLIFE AND FISHERIES

DATE: 11/20/17
PAGE 1 OF 9

FILE: P:\2017\2017.004\DWG\PRODUCTION\PERMIT DRAWINGS\PHASE 02 STRUCTURE PIERS\2017.004_PIERs VICINITY NEW.DWG

Figure E-7a. Pointe-aux-Chenes Wildlife Management Area Recreation Use Enhancement, fishing piers at water control structures.

THESE PLATS ARE TO BE USED FOR PERMITTING ONLY. THIS DOCUMENT IS NOT TO BE USED FOR CONSTRUCTION, BIDDING, RECORDATION, CONVEYANCE OR SALES.

DAVID F. BOUDREAU, P.E.
 LICENSE # 28239
 DELTA COAST CONSULTANTS

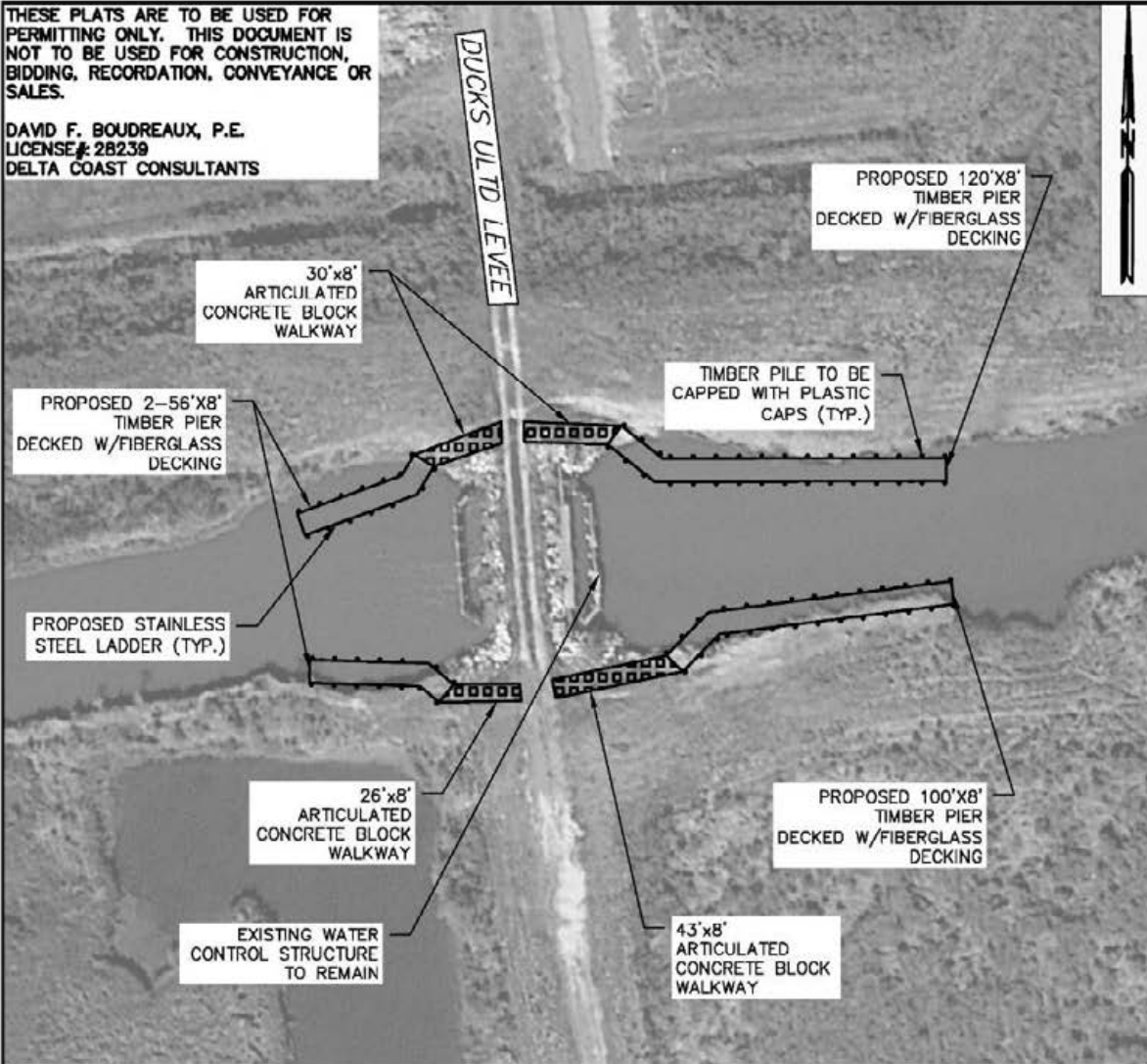

STRUCTURE 1 PLAN VIEW

SCALE: 1" = 50'

SCALE IN FEET



PROPOSED FISHING PIERS/DOCKS TO BE CONSTRUCTED
 IN POINTE-AUX-CHENES WILDLIFE MANAGEMENT AREA
 LOCATED IN SEC. 26&29, T19S-R19E, SEC. 08, T19S-R20E, &
 SEC. 33&29, T18S-R20E
 TERREBONNE & LAFOURCHE PARISHES, LOUISIANA

 **DELTA COAST**
 CONSULTANTS, LLC
 4924 HWY 311 - HOUMA, LA 70360
 PHONE: 985-655-3100 www.deltacoastllc.com

APPLICANT: LOUISIANA DEPARTMENT OF
 WILDLIFE AND FISHERIES

DATE: 11/20/17
 SHEET 2 OF 9

Figure E-7b. Pointe-aux-Chenes Wildlife Management Area Recreation Use Enhancement, fishing piers at water control structures.

THESE PLATS ARE TO BE USED FOR PERMITTING ONLY. THIS DOCUMENT IS NOT TO BE USED FOR CONSTRUCTION, BIDDING, RECORDATION, CONVEYANCE OR SALES.

DAVID F. BOUDREAU, P.E.
 LICENSE # 28239
 DELTA COAST CONSULTANTS

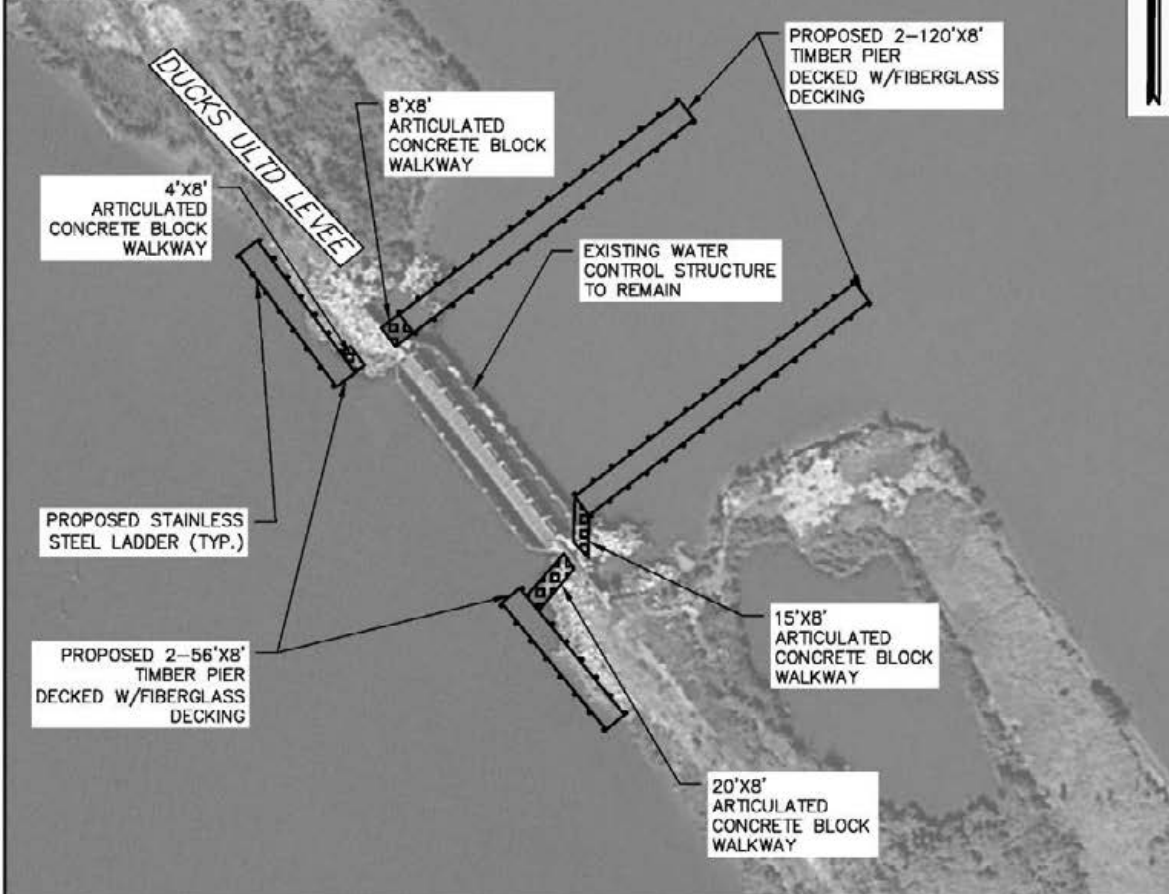

STRUCTURE 2 PLAN VIEW

SCALE: 1" = 50'

SCALE IN FEET



PROPOSED FISHING PIERS/DOCKS TO BE CONSTRUCTED
 IN POINTE-AUX-CHENES WILDLIFE MANAGEMENT AREA
 LOCATED IN SEC. 26&29, T19S-R19E, SEC. 08, T19S-R20E, &
 SEC. 33&29, T18S-R20E
 TERREBONNE & LAFORCHE PARISHES, LOUISIANA



APPLICANT: LOUISIANA DEPARTMENT OF
 WILDLIFE AND FISHERIES

DATE: 11/20/17
 SHEET 3 OF 9

Figure E-7c. Pointe-aux-Chenes Wildlife Management Area Recreation Use Enhancement, fishing piers at water control structures.

THESE PLATS ARE TO BE USED FOR PERMITTING ONLY. THIS DOCUMENT IS NOT TO BE USED FOR CONSTRUCTION, BIDDING, RECORDATION, CONVEYANCE OR SALES.

DAVID F. BOUDREAU, P.E.
 LICENSE # 28239
 DELTA COAST CONSULTANTS

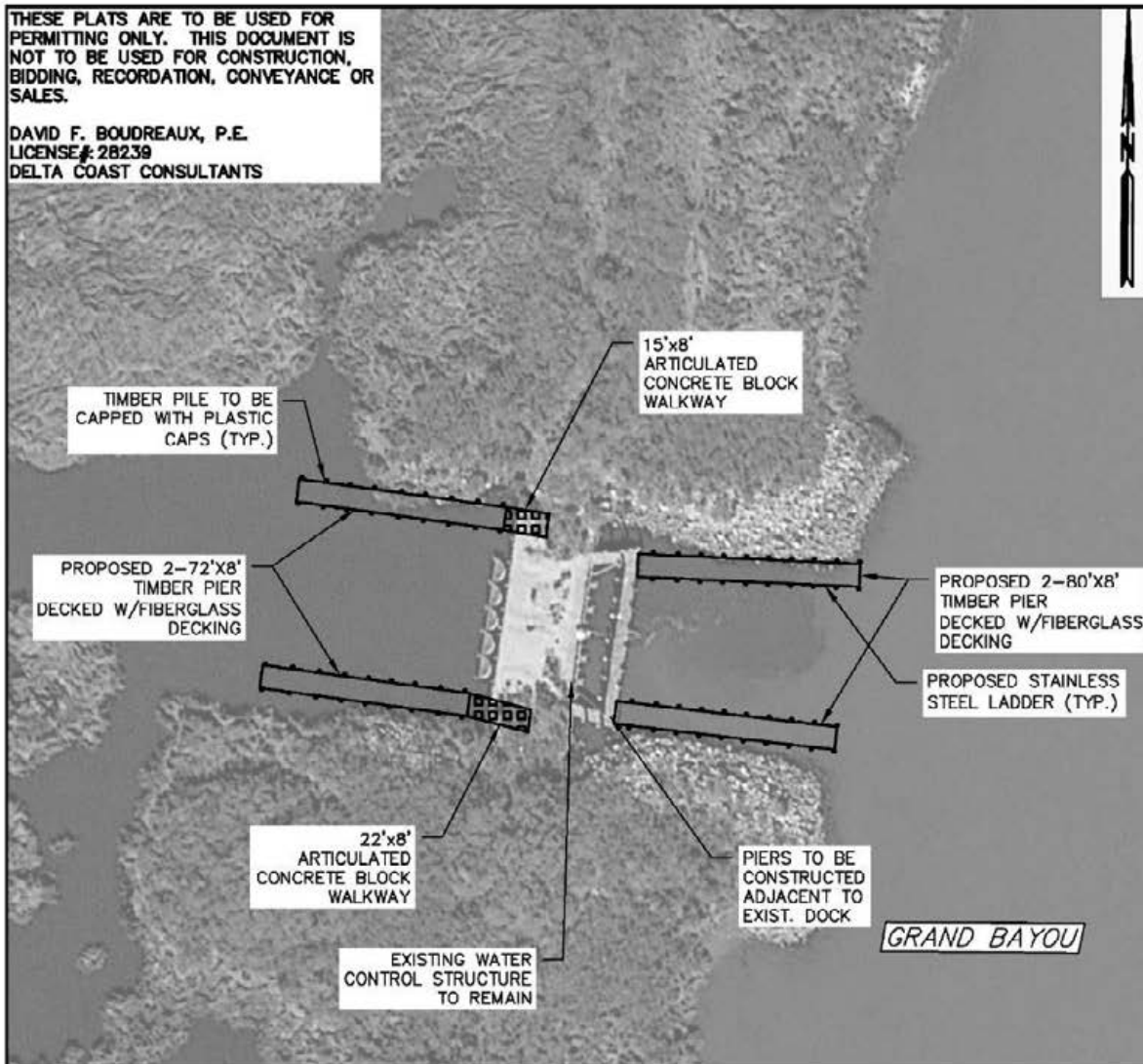

STRUCTURE 3 PLAN VIEW

SCALE: 1" = 50'

SCALE IN FEET

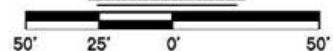

PROPOSED FISHING PIERS/DOCKS TO BE CONSTRUCTED
 IN POINTE-AUX-CHENES WILDLIFE MANAGEMENT AREA
 LOCATED IN SEC. 26&29, T19S-R19E, SEC. 08, T19S-R20E, &
 SEC. 33&29, T18S-R20E
 TERREBONNE & LAFOURCHE PARISHES, LOUISIANA



APPLICANT: LOUISIANA DEPARTMENT OF WILDLIFE AND FISHERIES

DATE: 11/20/17
 SHEET 4 OF 9

Figure E-7d. Pointe-aux-Chenes Wildlife Management Area Recreation Use Enhancement, fishing piers at water control structures.

THESE PLATS ARE TO BE USED FOR PERMITTING ONLY. THIS DOCUMENT IS NOT TO BE USED FOR CONSTRUCTION, BIDDING, RECORDATION, CONVEYANCE OR SALES.

DAVID F. BOUDREAU, P.E.
 LICENSE # 28239
 DELTA COAST CONSULTANTS

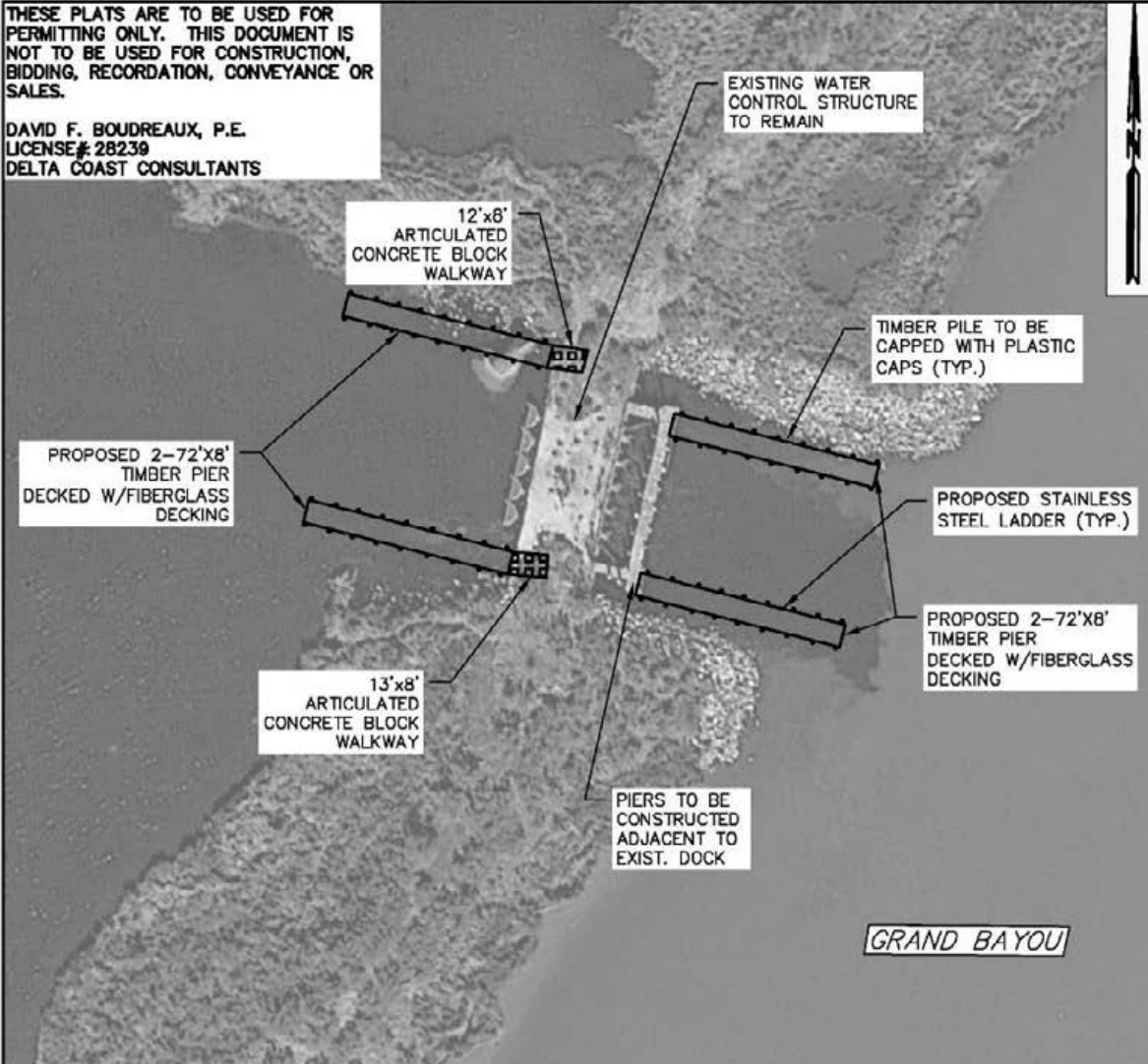

STRUCTURE 4 PLAN VIEW

SCALE: 1" = 50'

SCALE IN FEET



PROPOSED FISHING PIERS/DOCKS TO BE CONSTRUCTED IN POINTE-AUX-CHENES WILDLIFE MANAGEMENT AREA LOCATED IN SEC. 26&29, T19S-R19E, SEC. 08, T19S-R20E, & SEC. 33&29, T18S-R20E TERREBONNE & LAFOURCHE PARISHES, LOUISIANA



APPLICANT: LOUISIANA DEPARTMENT OF WILDLIFE AND FISHERIES

DATE: 11/20/17
 SHEET 5 OF 9

Figure E-7e. Pointe-aux-Chenes Wildlife Management Area Recreation Use Enhancement, fishing piers at water control structures.

THESE PLATS ARE TO BE USED FOR PERMITTING ONLY. THIS DOCUMENT IS NOT TO BE USED FOR CONSTRUCTION, BIDDING, RECORDATION, CONVEYANCE OR SALES.

DAVID F. BOUDREAU, P.E.
 LICENSE # 28239
 DELTA COAST CONSULTANTS

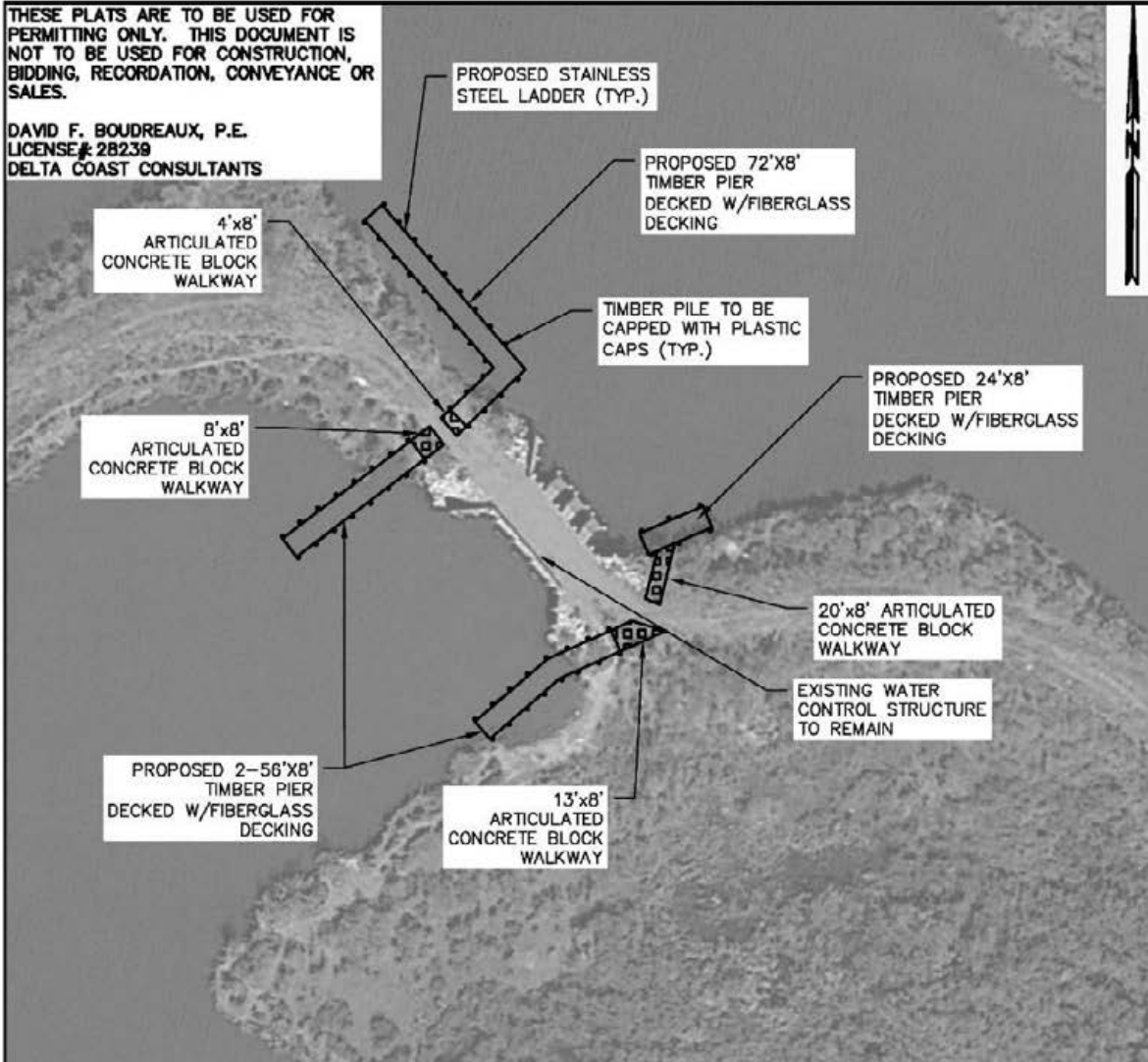

STRUCTURE 5 PLAN VIEW

SCALE: 1" = 50'

SCALE IN FEET



PROPOSED FISHING PIERS/DOCKS TO BE CONSTRUCTED
 IN POINTE-AUX-CHENES WILDLIFE MANAGEMENT AREA
 LOCATED IN SEC. 26&29, T19S-R19E, SEC. 08, T19S-R20E, &
 SEC. 33&29, T18S-R20E
 TERREBONNE & LAFOURCHE PARISHES, LOUISIANA



APPLICANT: LOUISIANA DEPARTMENT OF
 WILDLIFE AND FISHERIES

DATE: 11/20/17
 SHEET 6 OF 9

Figure E-7f. Pointe-aux-Chenes Wildlife Management Area Recreation Use Enhancement, fishing piers at water control structures.

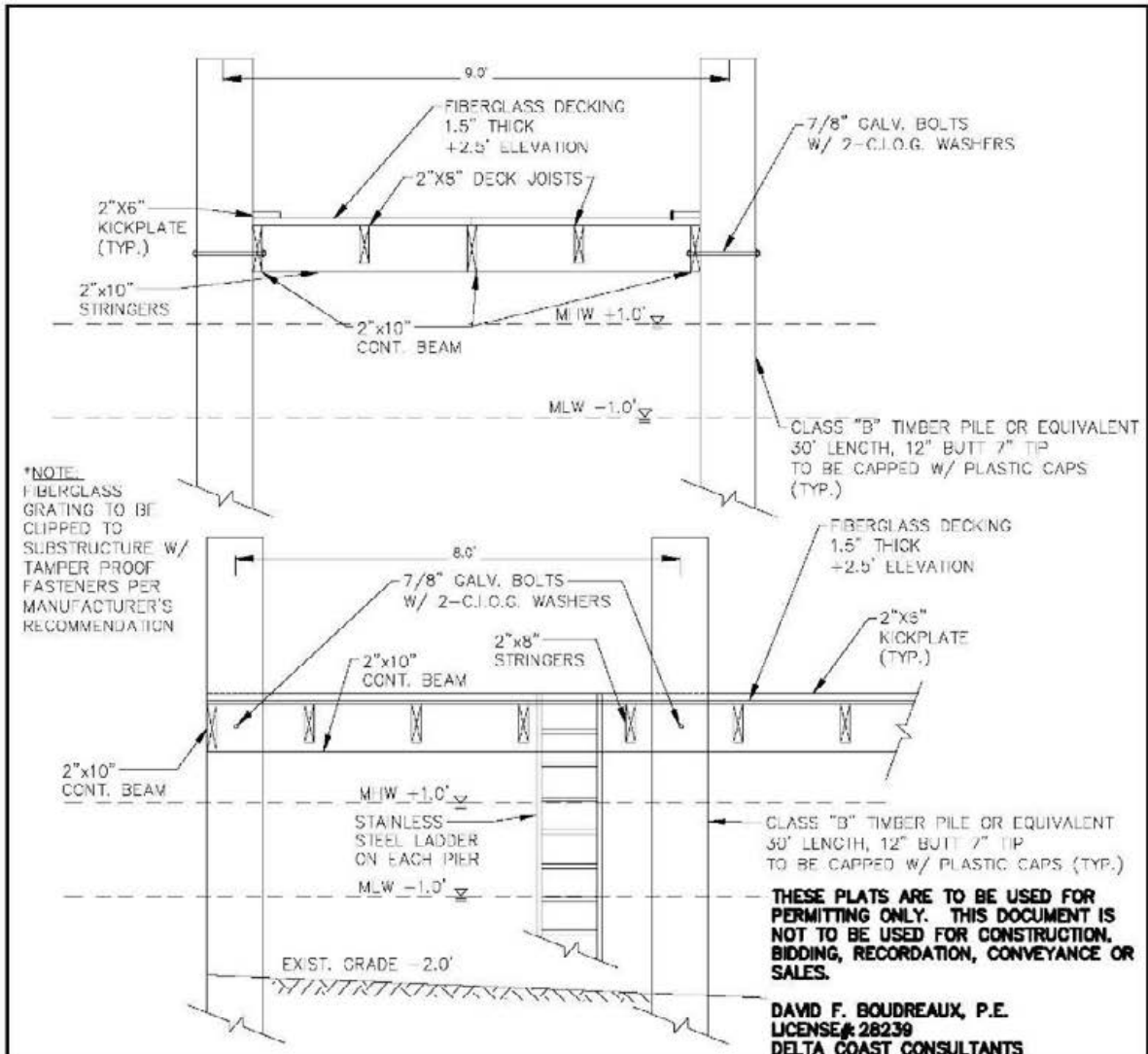

TYPICAL DOCK SECTION

NOT TO SCALE

PROPOSED FISHING PIERS/DOCKS TO BE CONSTRUCTED
IN GRAND BAYOU & SONGE WILDLIFE MANAGEMENT AREAS
LOCATED IN SEC. 26&29, T19S-R19E, SEC. 08, T19S-R20E, &
SEC. 33&29, T18S-R20E
POINTE-AUX-CHENES, TERREBONNE & LAFOURCHE PARISHES,
LOUISIANA



APPLICANT: LOUISIANA DEPARTMENT OF
WILDLIFE AND FISHERIES

DATE: 11/20/17
SHEET 7 OF 9

Figure E-7g. Pointe-aux-Chenes Wildlife Management Area Recreation Use Enhancement, fishing piers at water control structures.

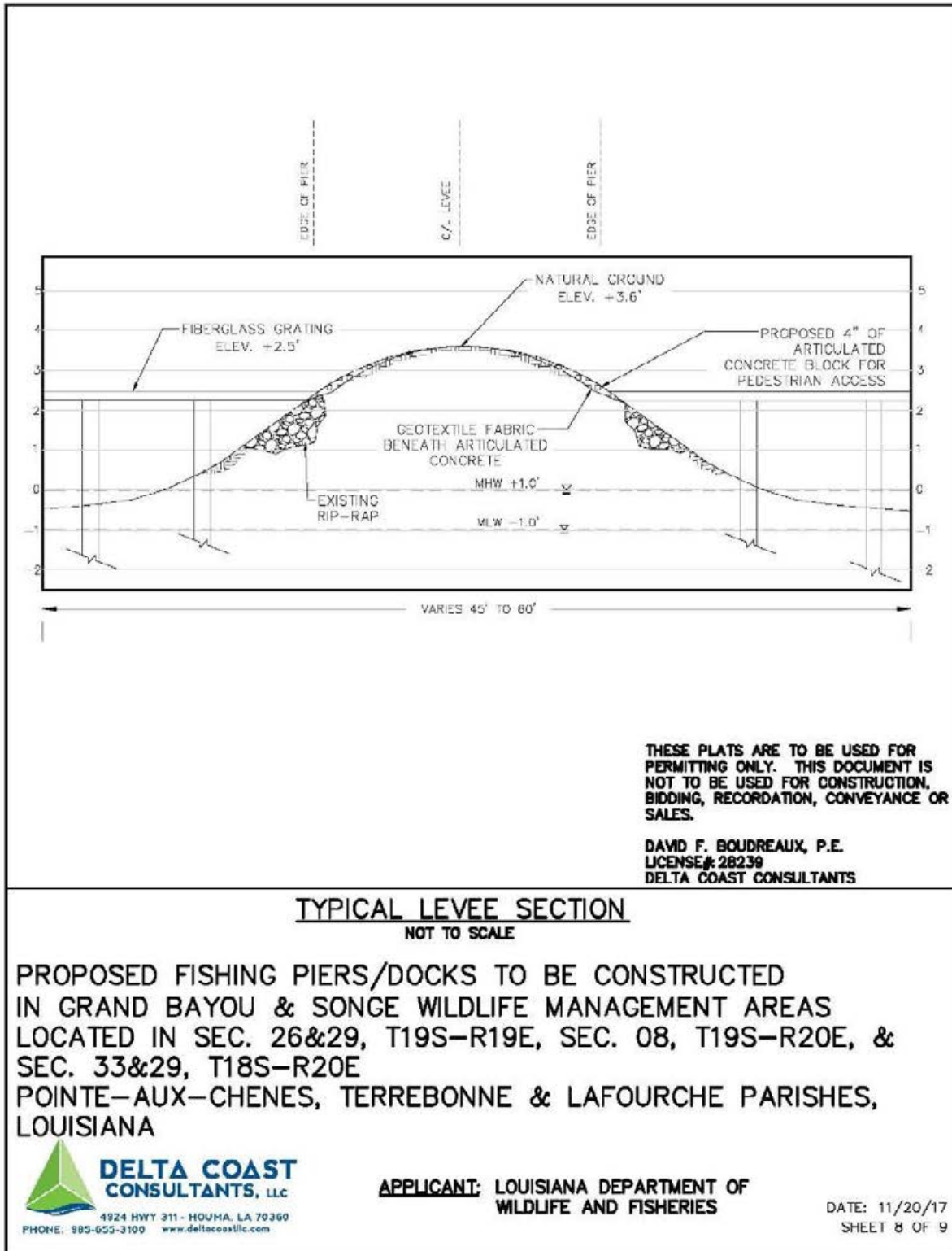

Figure E-7h. Pointe-aux-Chenes Wildlife Management Area Recreation Use Enhancement, fishing piers at water control structures.

THESE PLATS ARE TO BE USED FOR PERMITTING ONLY.
THIS DOCUMENT IS NOT TO BE USED FOR CONSTRUCTION,
BIDDING, RECORDATION, CONVEYANCE OR SALES.

DAVID F. BOUDREAU, P.E. LICENSE# 28239
DELTA COAST CONSULTANTS

NOTES:

1. ALL STRUCTURES, FACILITIES, WELLS AND PIPELINES/FLOWLINES OCCURRING IN OPEN WATER AREAS OR IN OILFIELD CANALS OR SLIPS SHALL BE REMOVED WITHIN 120 DAYS OF ABANDONMENT OF THE FACILITIES FOR THE HEREIN PERMITTED USE, UNLESS PRIOR WRITTEN APPROVAL TO LEAVE SUCH STRUCTURES IN PLACE IS RECEIVED FROM THE COASTAL MANAGEMENT DIVISION. THIS CONDITION DOES NOT PRECLUDE THE NECESSITY FOR REVISING THE CURRENT PERMIT OR OBTAINING A SEPARATE COASTAL USE PERMIT, SHOULD ONE BE REQUIRED, FOR SUCH REMOVAL ACTIVITIES.
2. AS-BUILT DRAWINGS SHALL BE SUBMITTED WITHIN 30 DAYS OF COMPLETION OF THIS PROJECT TO THE LOUISIANA DEPARTMENT OF NATURAL RESOURCES, COASTAL MANAGEMENT DIVISION, P.O. BOX 44487, BATON ROUGE, LA. 70804-4487.
3. STRUCTURES WILL BE MARKED/LIGHTED IN ACCORDANCE WITH U.S. COAST GUARD REGULATIONS.
4. IN ORDER TO ENSURE THE SAFETY OF ALL PARTIES, THE PERMITTEE SHALL CONTACT THE LOUISIANA ONE-CALL SYSTEM (1-800-272-3020) A MINIMUM OF 48 HOURS PRIOR TO THE COMMENCEMENT OF ANY EXCAVATION (DIGGING, DREDGING, JETTING, ETC.) OR DEMOLITION ACTIVITY.

QUANTITIES:

	<u>ARTICULATED CONCRETE MATS</u>	<u>NO. OF PILES</u>
STRUCTURE 1	93 S.Y.	88
STRUCTURE 2	32 S.Y.	96
STRUCTURE 3	33 S.Y.	80
STRUCTURE 4	23 S.Y.	72
STRUCTURE 5	35 S.Y.	52

EQUIPMENT:

1. TUG BOAT
2. BARGE
3. CRANE
4. 14' BOAT
5. LONG REACH EXCAVATOR

NOTES AND QUANTITIES

PROPOSED FISHING PIERS/DOCKS TO BE CONSTRUCTED
IN GRAND BAYOU & SONGE WILDLIFE MANAGEMENT AREAS
LOCATED IN SEC. 26&29, T19S-R19E, SEC. 08, T19S-R20E, &
SEC. 33&29, T18S-R20E
POINTE-AUX-CHENES, TERREBONNE & LAFOURCHE PARISHES,
LOUISIANA



APPLICANT: LOUISIANA DEPARTMENT OF
WILDLIFE AND FISHERIES

DATE: 11/20/17
SHEET 9 OF 9

Figure E-7i. Pointe-aux-Chenes Wildlife Management Area Recreation Use Enhancement, fishing piers at water control structures.

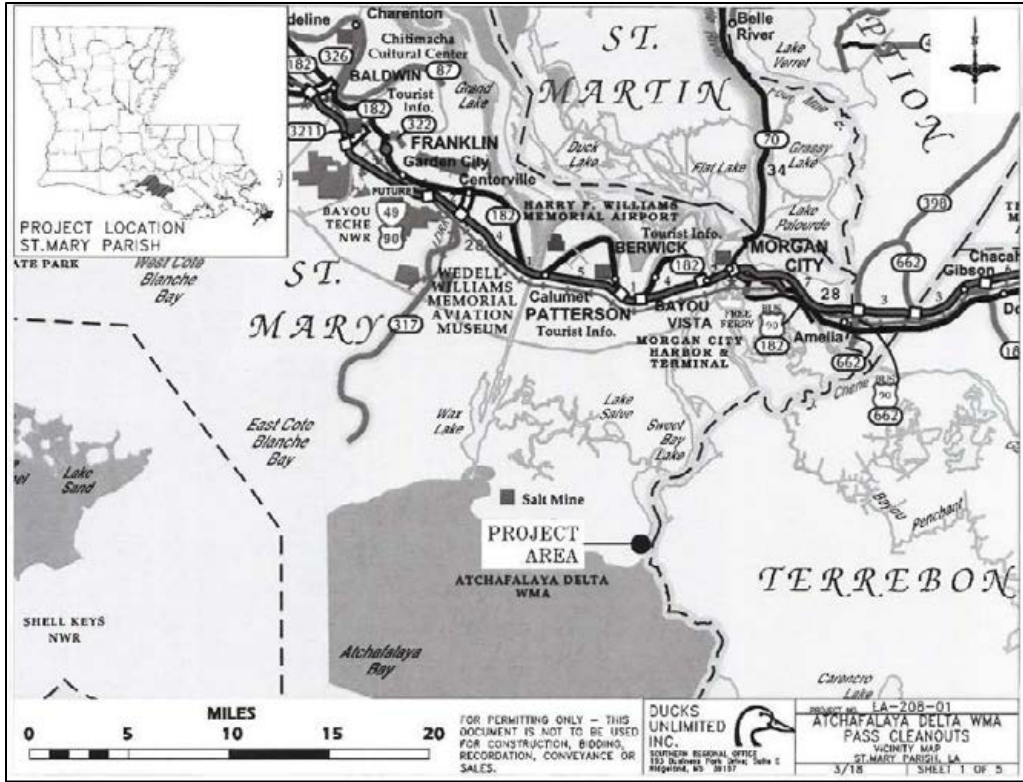

Figure E-8a. Atchafalaya Delta Wildlife Management Area Access.

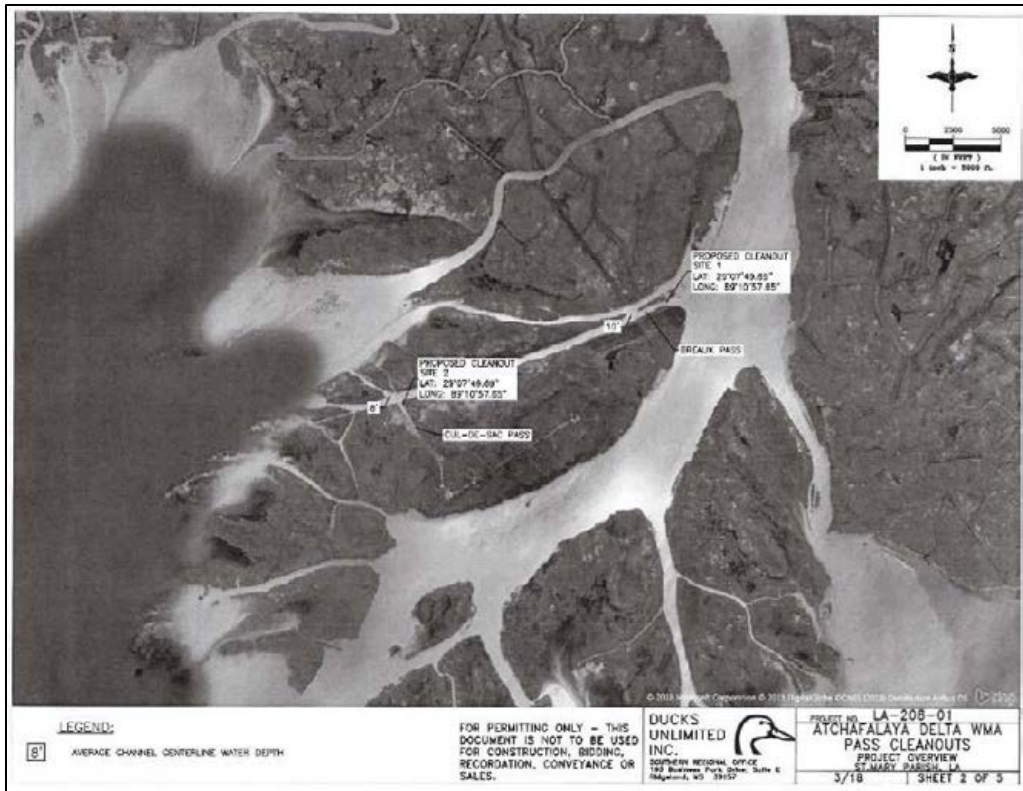

Figure E-8b. Atchafalaya Delta Wildlife Management Area Access.

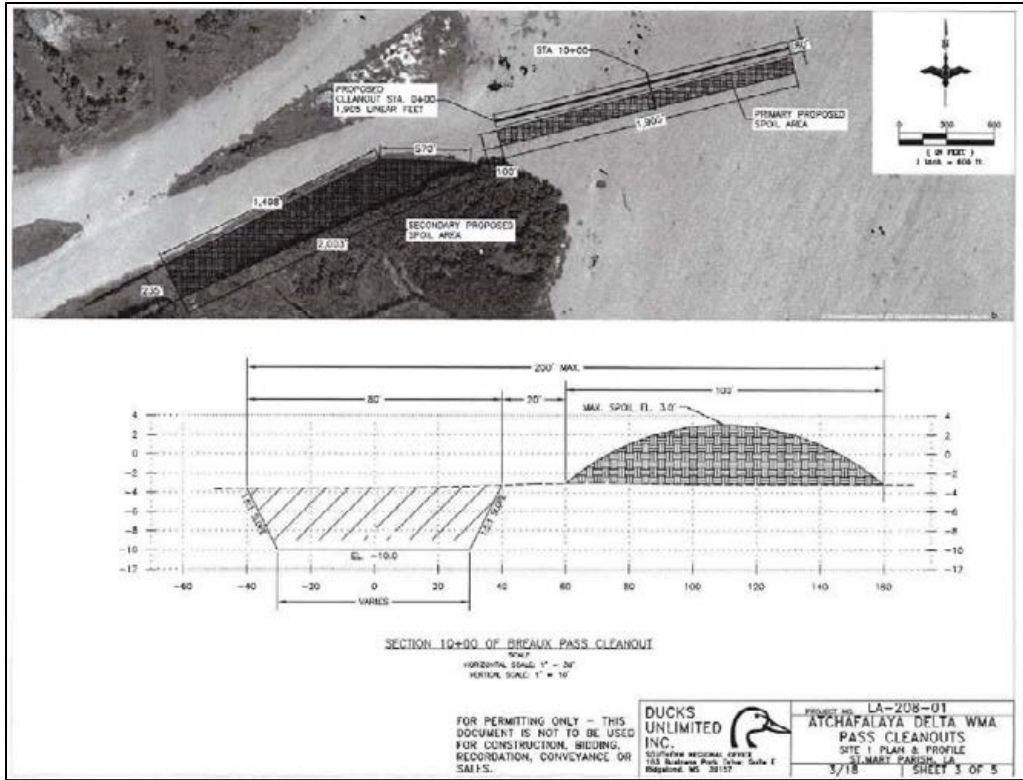

Figure E-8c. Atchafalaya Delta Wildlife Management Area Access.

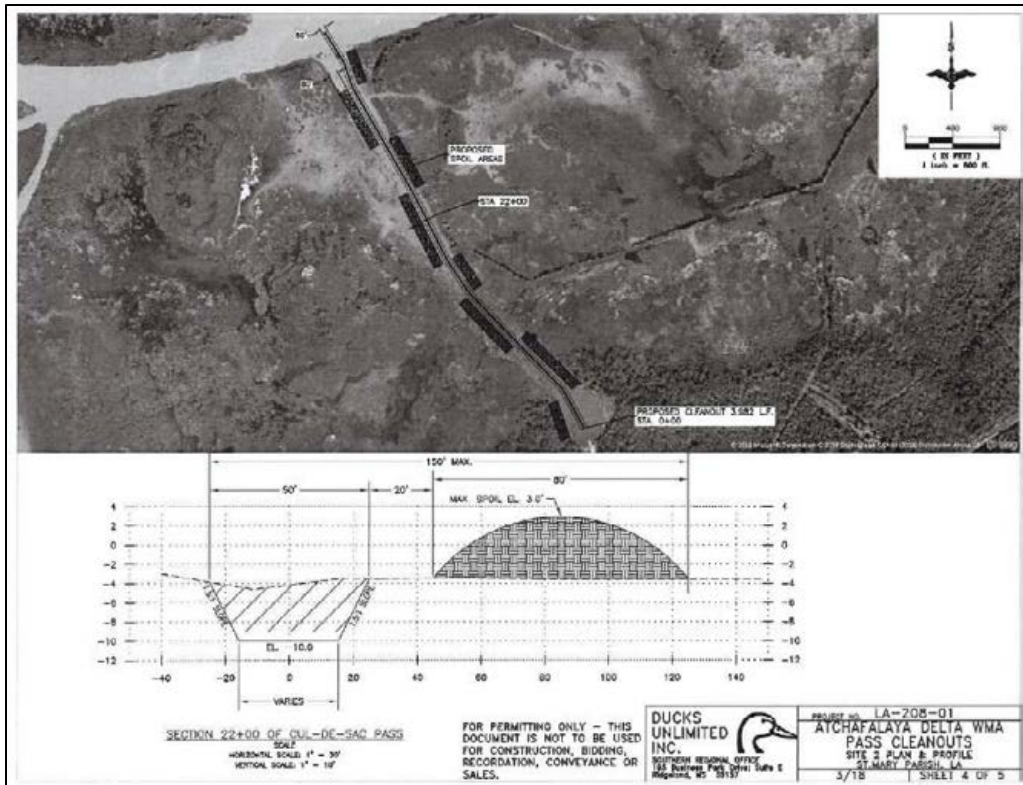

Figure E-8d. Atchafalaya Delta Wildlife Management Area Access.

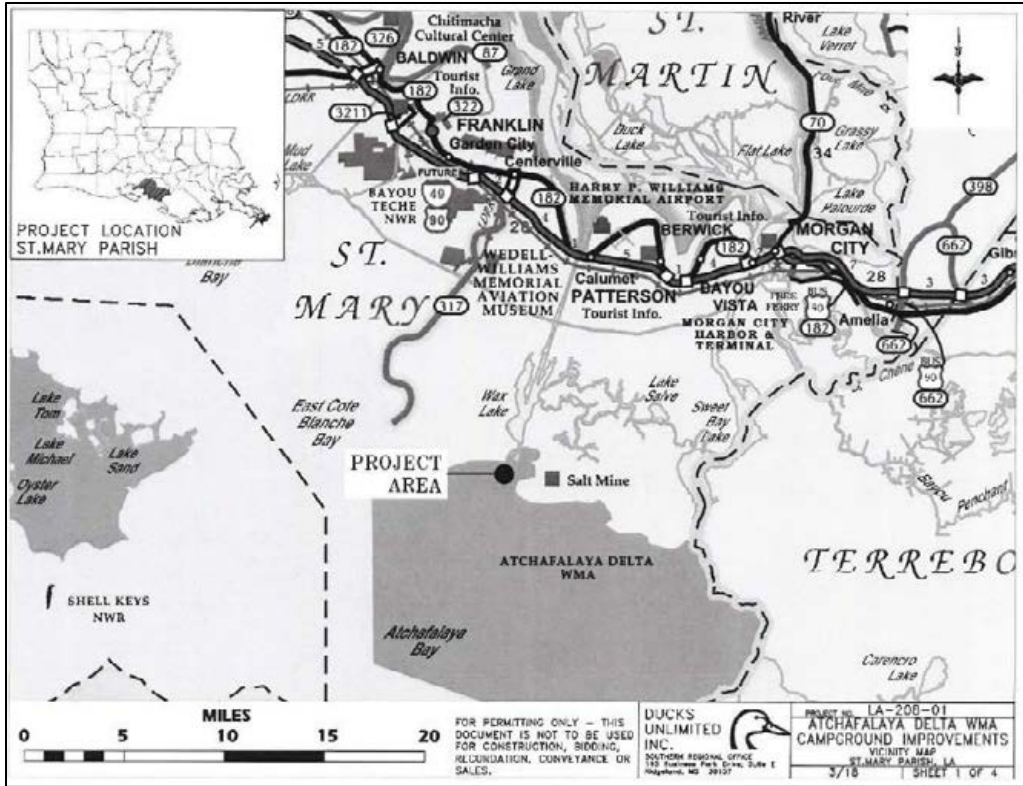

Figure E-9a. Atchafalaya Delta Wildlife Management Area Campgrounds.

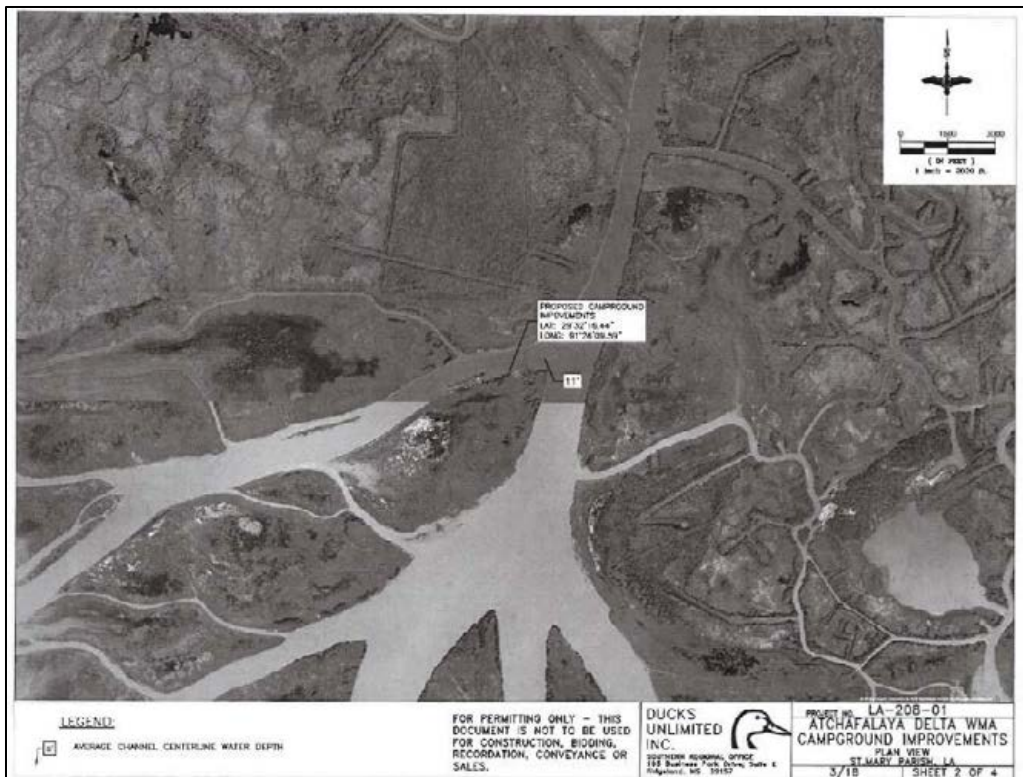

Figure E-9b. Atchafalaya Delta Wildlife Management Area Campgrounds.

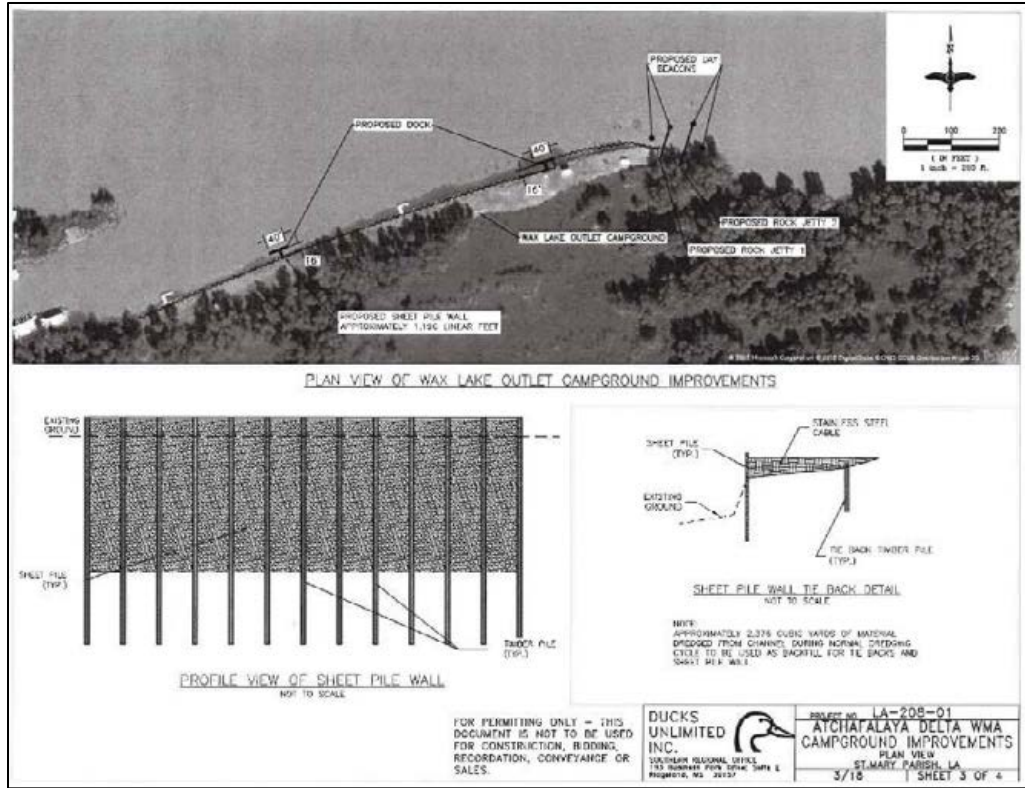

Figure E-9c. Atchafalaya Delta Wildlife Management Area Campgrounds.

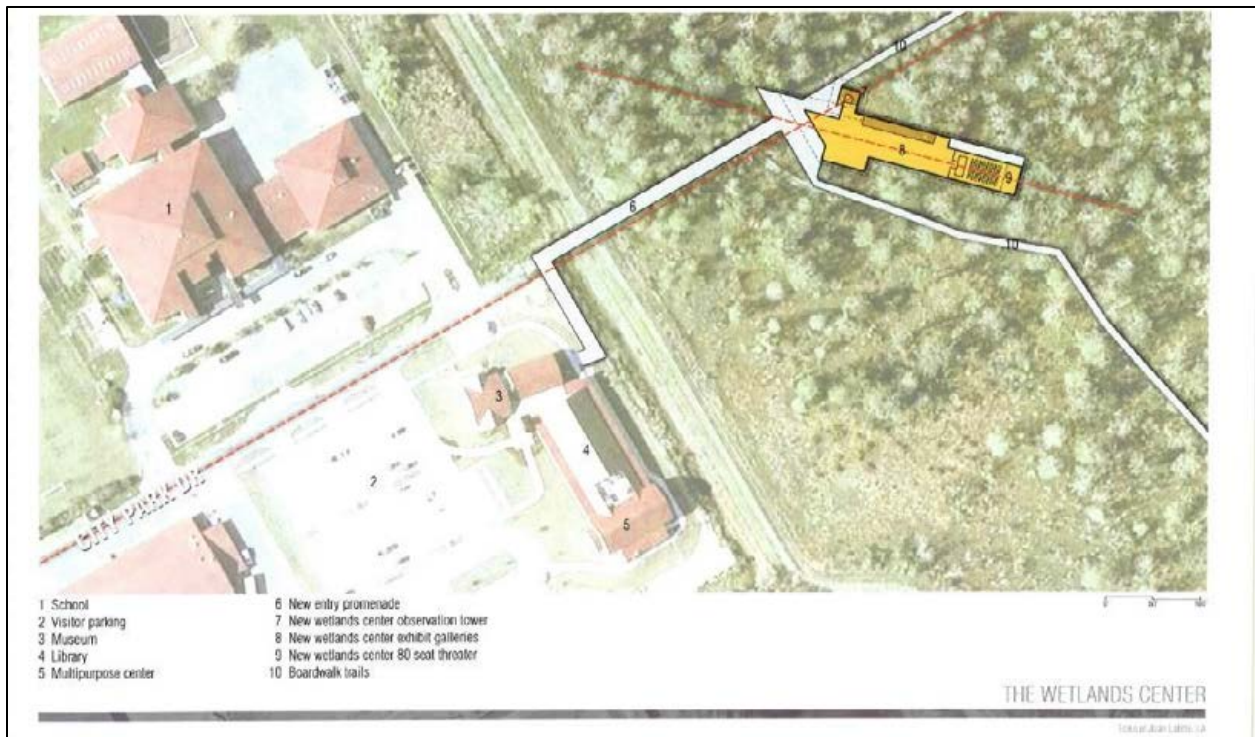

Figure E-10a. The Wetlands Center.

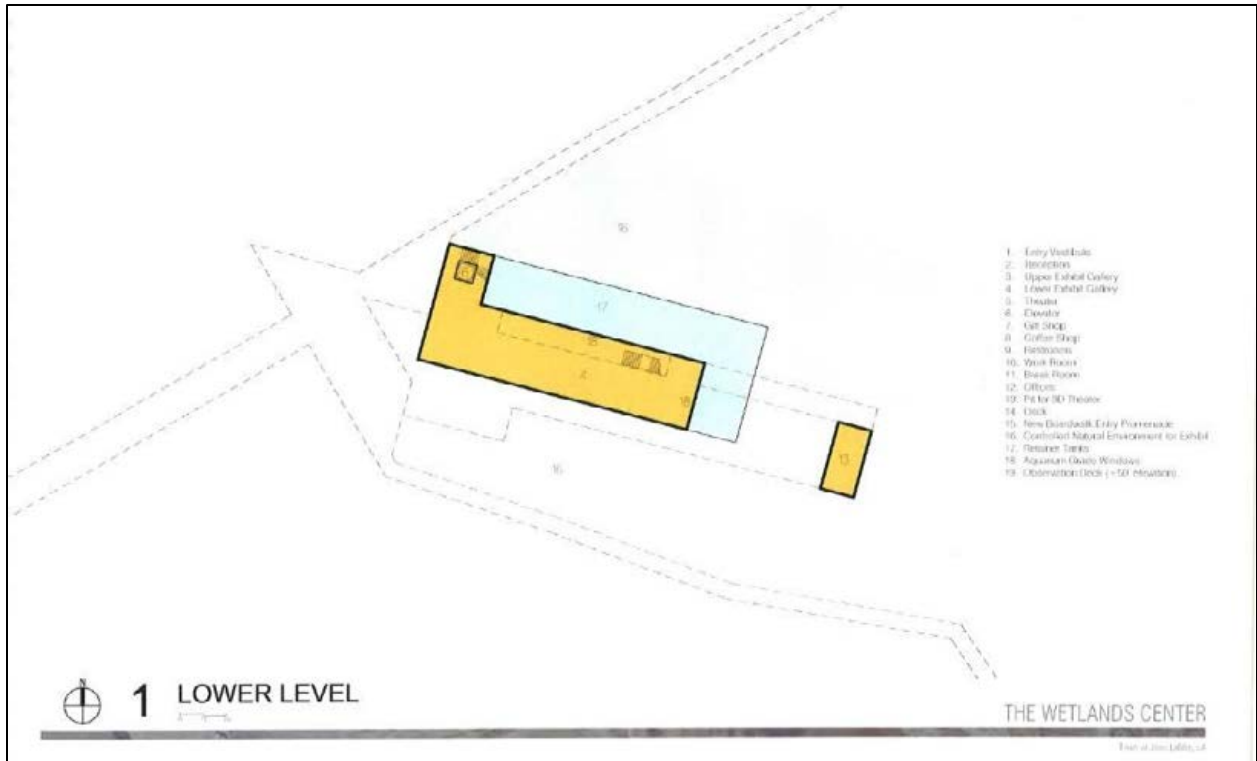

Figure E-10b. The Wetlands Center.

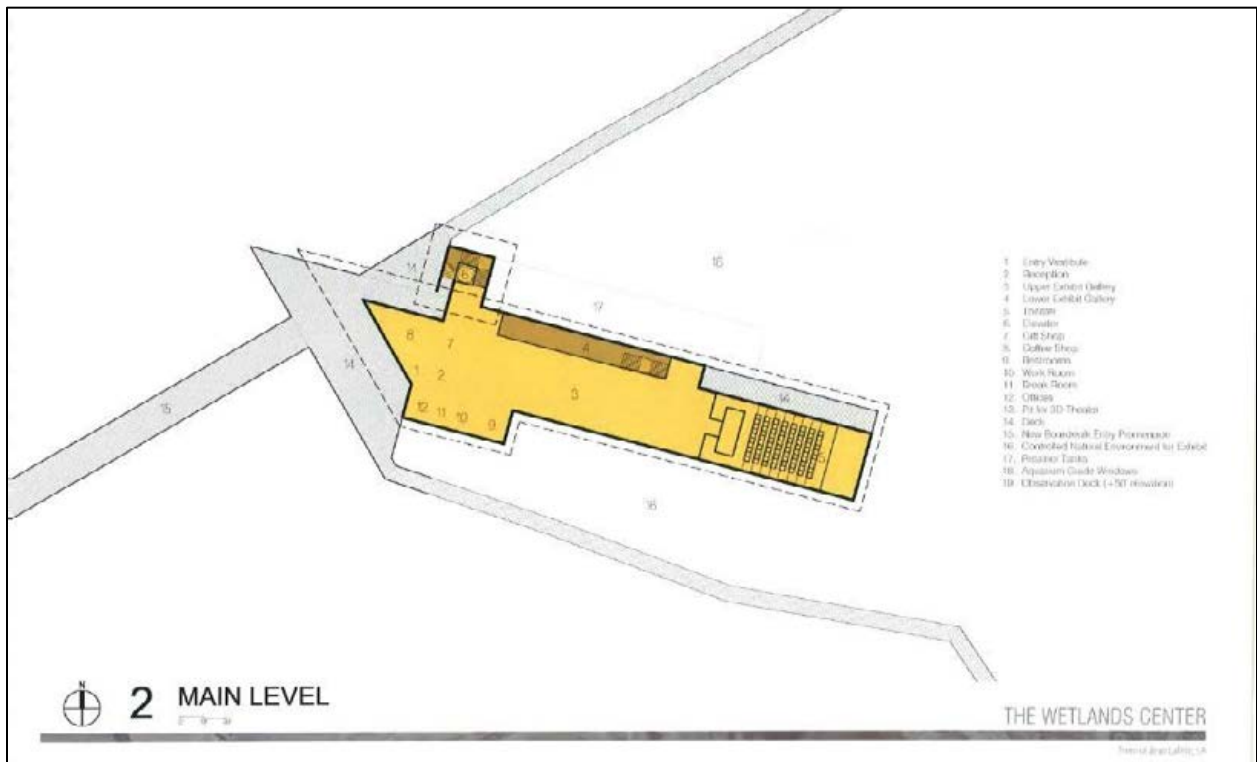

Figure E-10c. The Wetlands Center.

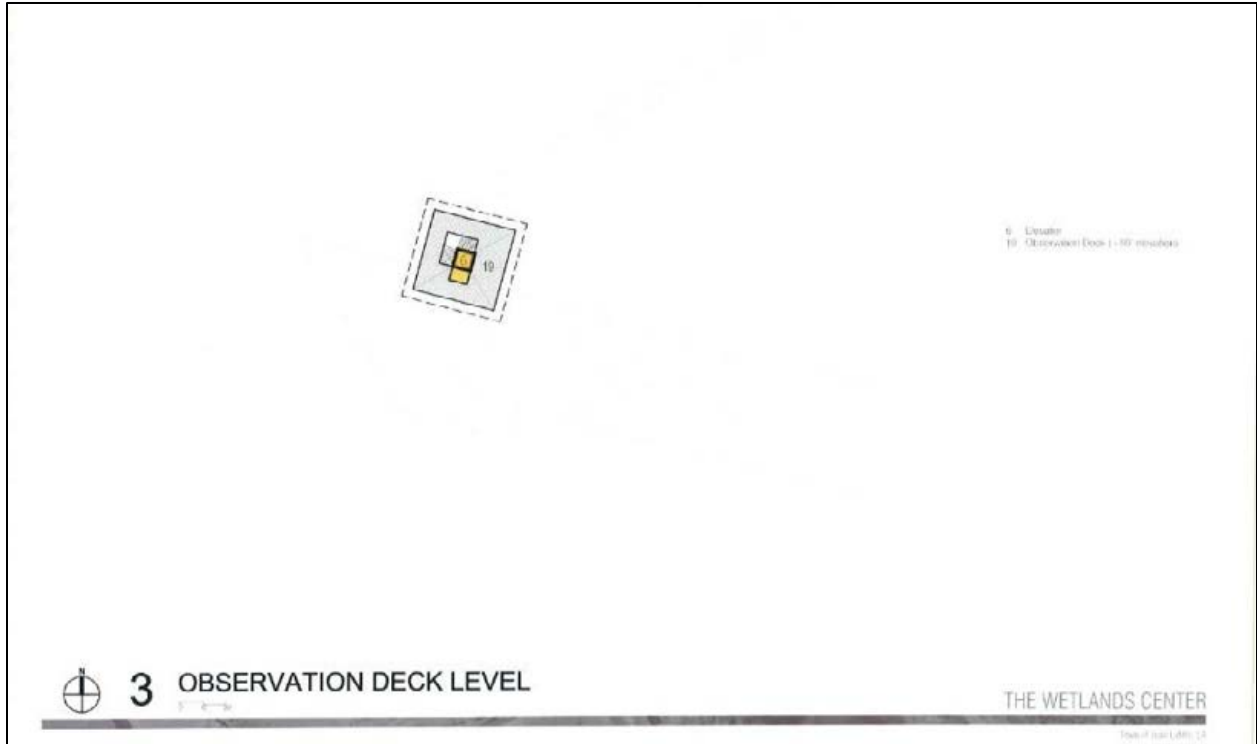

Figure E-10d. The Wetlands Center.

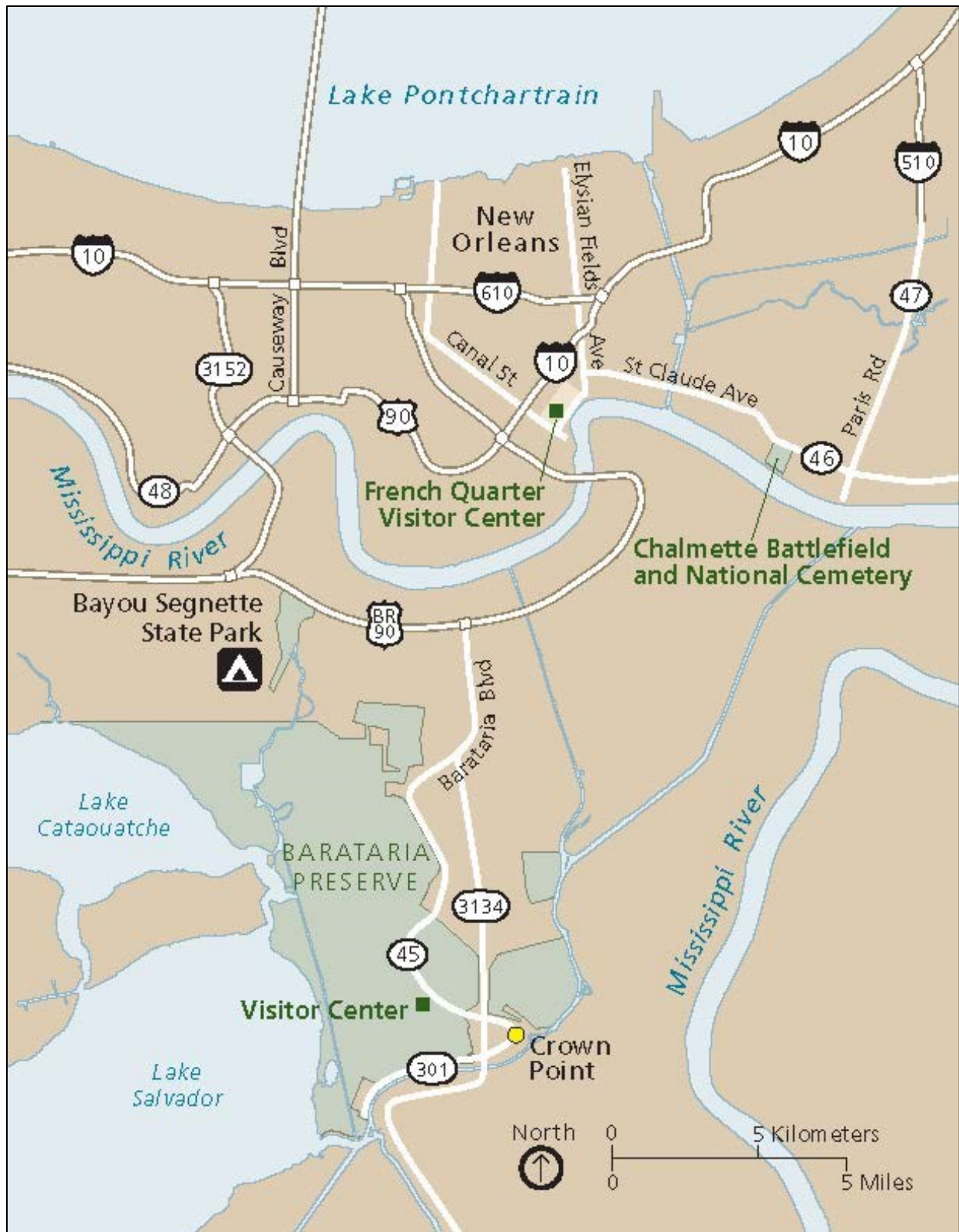

Figure E-11. Jean Lafitte National Historic Park and Preserve, Barataria Preserve Unit.



Figure E-12a. Des Allemands Boat Launch in St. Charles Parish.



Figure E-12b. Des Allemands Boat Launch in St. Charles Parish.



Figure E-12c. Des Allemands Boat Launch in St. Charles Parish.

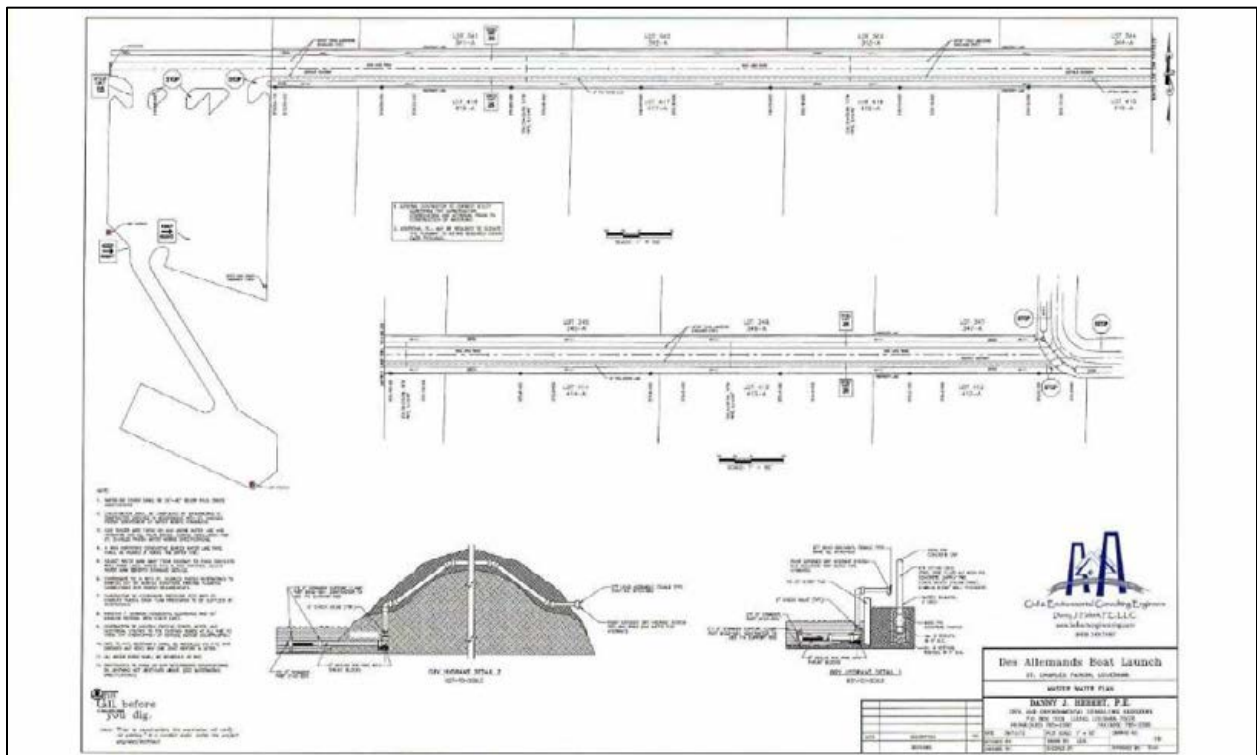

Figure E-12d. Des Allemands Boat Launch in St. Charles Parish.

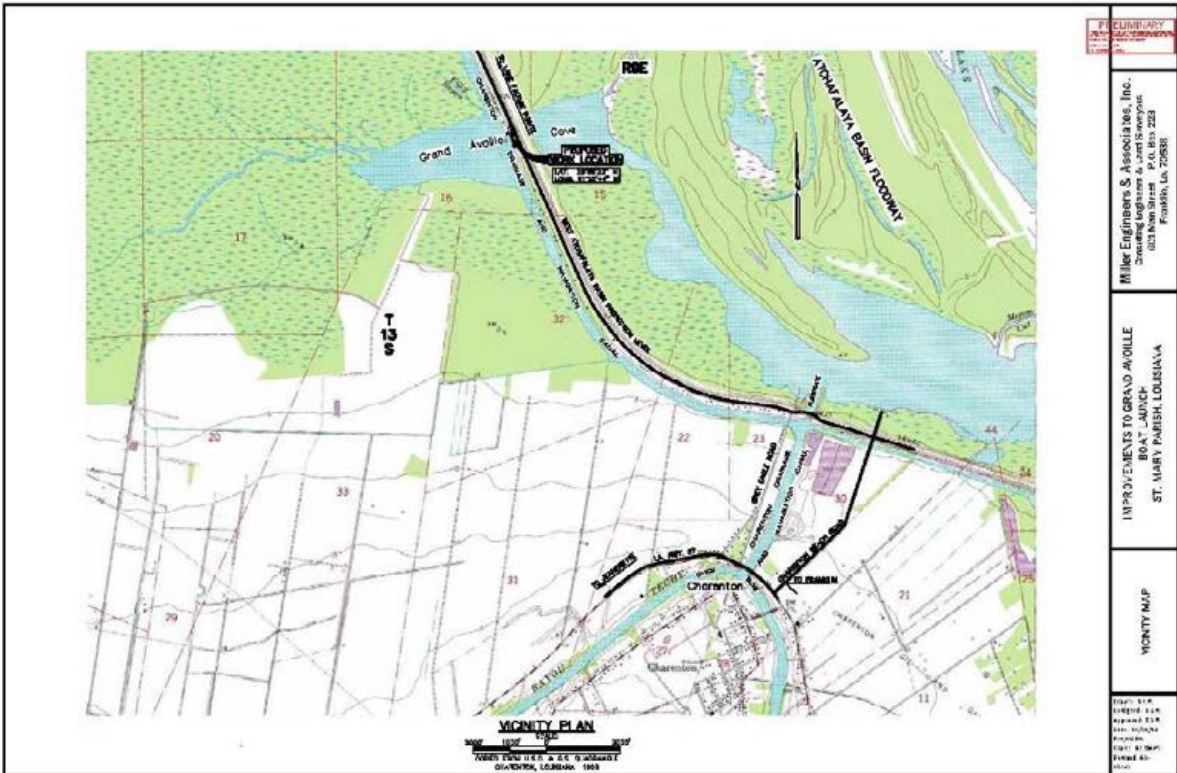

Figure E-13a. Improvements to Grand Avoille Boat Launch in St. Mary Parish.



Figure E-13b. Improvements to Grand Avoille Boat Launch in St. Mary Parish.



Figure E-13c. Improvements to Grand Avoille Boat Launch in St. Mary Parish.